

48
YEARS OF PASSION
FOR INNOVATION

KOCCEL[®]

"Organized Solutions..."



www.kocel.com.tr



Drawer Cabinets 4-19



Cnc Tool Cabinets 20-23



Computer Working Cabinets 24-25



Industrial Cabinets 26-33



Material Cabinets 34-39

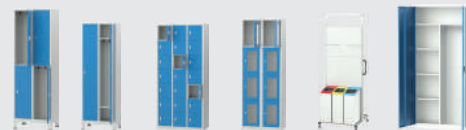

Ppe Lockers 40-43



Linbin Systems 44-51



Workbenches 52-87



Mobile Workbenches 88-95



Tool Carts 96-101



Handling Carts 102-103

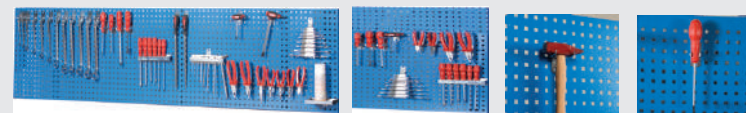

Pegboards 104-105



Shelf Systems 106-111



Accessory 112

KOÇEL TIMELINE

- 1977 - KOÇEL A.Ş. was established in Zeytinburnu, Istanbul in a 200m² area.
- 1979 - Started producing steel and formica-coated household furniture.
- 1985 - Produced the first drawer cabinet following the special request and design of a customer.
- 1992 - Continued to produce drawer cabinets based on the demand from customers after trial samples were made.
- 2002 - The first year we participated in an exhibition.

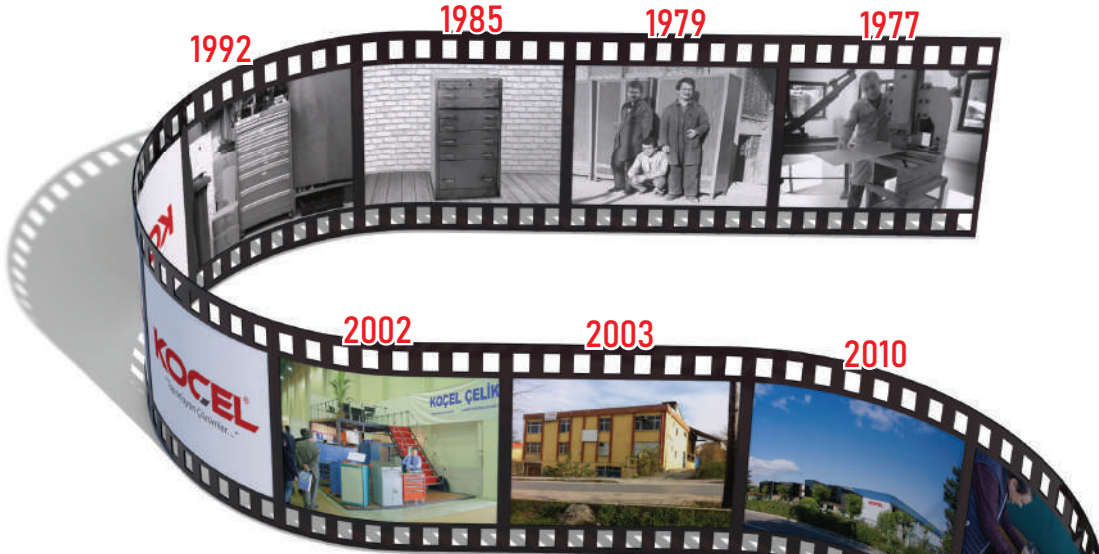

- 2003 - A factory was established in Mahmutbey, covering 1200m², and the product range expanded along with a team of 25 people.
- 2010 - The factory building in the GOSB (Gebze Organized Industrial Zone), covering 7500m², was purchased and production continued there. KOÇEL A.Ş., with its advanced technology and team of skilled professionals, not only expanded its product range but also strengthened its position in the industry by increasing its customer potential.

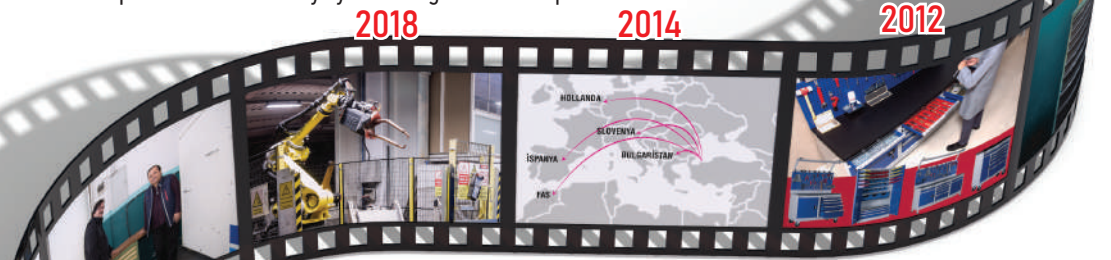

- 2012 - Expanded product range.
- 2014 - The first years we started exporting; we exported to Spain, the Netherlands, Slovenia, Bulgaria, and Morocco.
- 2018 - KOÇEL A.Ş. adapted its production and products to the latest technologies and continued expanding.
- 2020 - Continued to expand the machine park with the latest technological machine investments due to increasing business volume.
- 2023 - In 2023, we doubled our production area by incorporating the second KOÇEL factory building into our operations.



- 2027 - Our future factory.

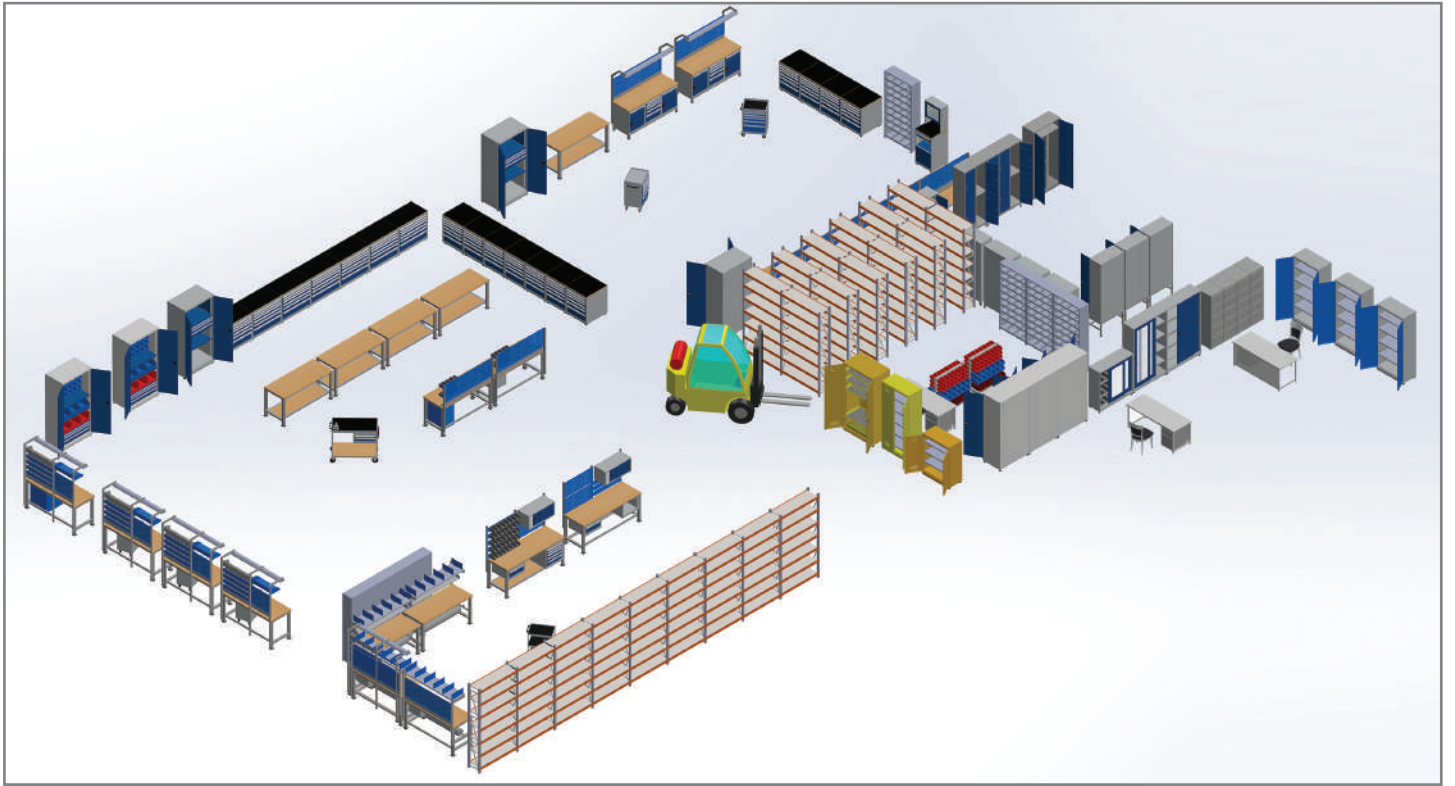

FARPLAS A.Ş.

Okan AKBULUT
Layout and New Investments
Specialist

When we think of KOÇEL A.Ş., the first thing that comes to our mind is Giresunspor. After using KOÇEL's high quality products, we started to utilize our working spaces more efficiently. The reason we chose KOÇEL A.Ş. was the high quality of their products, the fast customer support we received, and their ability to meet our additional requests.



SAMSUN YURT SAVUNMA

Selçuk TEMELİ
Technical Manager

We use Koçel's products across many of our departments. We prefer them due to their functionality and durability. Additionally, the company values customer feedback. When we request custom-designed products, we receive prompt and solution-oriented responses.



YILDIZ TEKNİK ÜNİVERSİTESİ

Ass. Prof. Alptekin ERGENÇ
Vice President, Dep. for Machine
Engineering

During the renovation of our Automotive Laboratory and the YTU Racing garage, various KOÇEL A.Ş. products were chosen, which brought about a visual and functional harmony appreciated by all the students and guests who visit the laboratory. We believe that the paint quality, material quality, and customer satisfaction approach were the main reasons for the harmony in these workspaces.



TOYOTETSU TÜRKİYE

Fikret YAVUZ
Assistant Manager of Human
Resources and Administrative
Affairs

When we think of KOÇEL A.Ş., the first thing that comes to our mind is quality. Thanks to the variety and special designs, KOÇEL A.Ş. products brought order and organization to our company. The fact that the products are long-lasting and provide smooth, easy usage was the most important reason for our preference. Since KOÇEL A.Ş. products are high quality and durable, we have been using them seamlessly for many years.



GES GENEL ELEKTRİK SİSTEMLERİ

Musa ÇORBACI
Chairman of the Board

When we moved to our new facility, we organized our warehouse section with solutions provided by KOÇEL. We managed this process very quickly and easily thanks to their solution-oriented and professional approach. Not only their quality but also the after-sales support they provided was very helpful to us. We thank the KOÇEL family for this performance.



YUKİ

Aydan ALPAZAR
Spare Parts Manager

We have been using KOÇEL A.Ş.'s products for years, and we find them extremely useful. Their products helped us establish a more comfortable and systematic organization. Since KOÇEL prioritizes service and quality, we never even considered another brand, because we know that good quality, good service, and good prices will always keep them ahead.



SARIGÖL KONVOYÖR

Mustafa KARA
Purchasing and Warehouse
Manager

In our new factory, we purchased all the station systems, shelving systems, and employee locker cabinets from KOÇEL. We have been using them smoothly without any problems for more than two years. KOÇEL's quality and high standards have made us very satisfied. As the Sarigöl family, thanks to the KOÇEL family for this performance.



GİRSAN SİLAH

Hamdi Can OTURAK
Mechanical Engineer

In 2021, we moved to our new factory, where we equipped all the working areas with KOÇEL products. As the years passed, we realized how right our decision was. The quality and ergonomic usage of KOÇEL products have not only facilitated our work but also provided strength and durability, creating solutions that organized our entire factory.



18X27 E

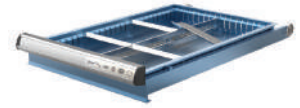
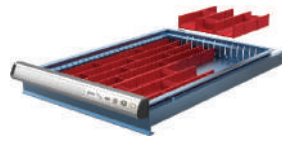
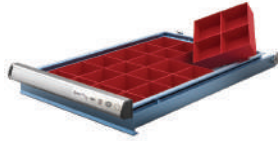
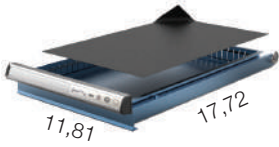

Central Lock



Ball Joint Feet

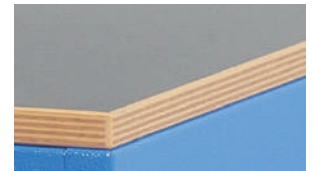

0,71inch MC Chipboard Top



Professional Labelling

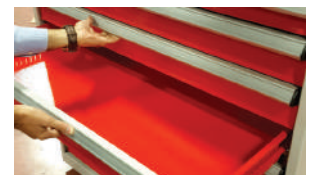

Secure Drawer



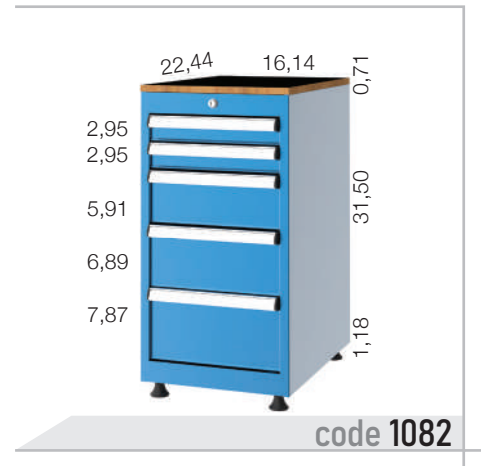
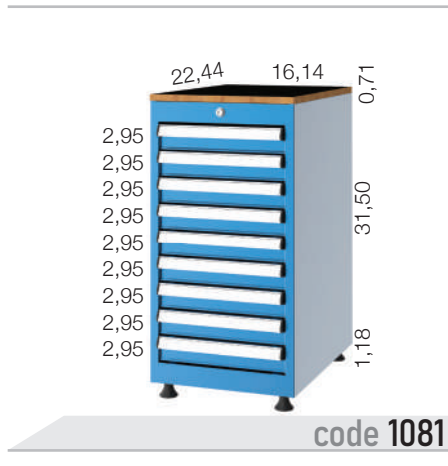
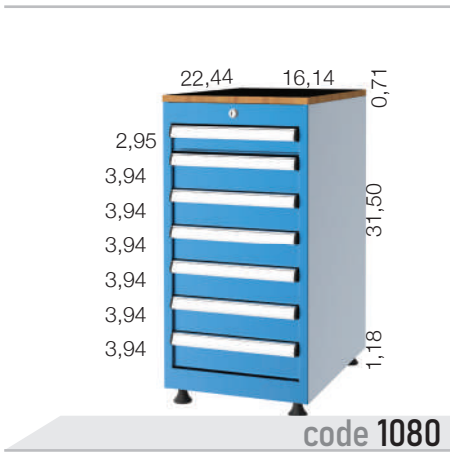
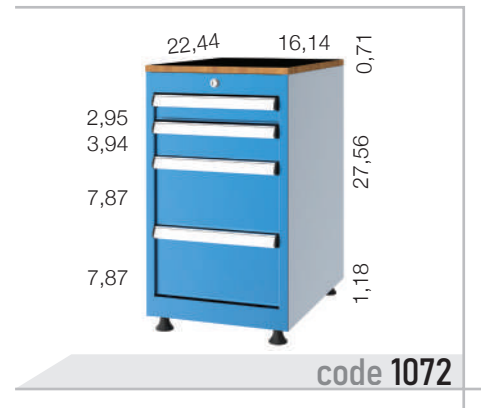
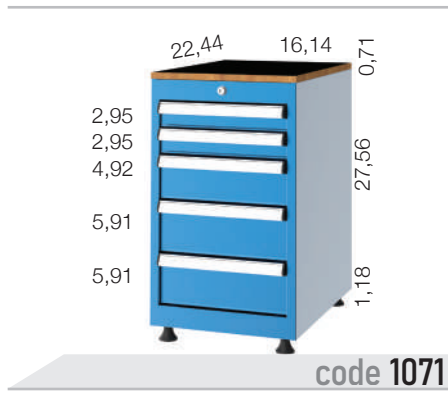
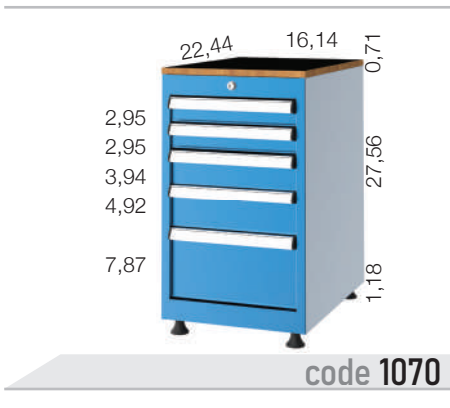
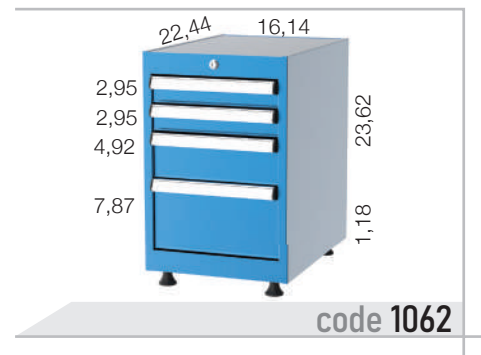
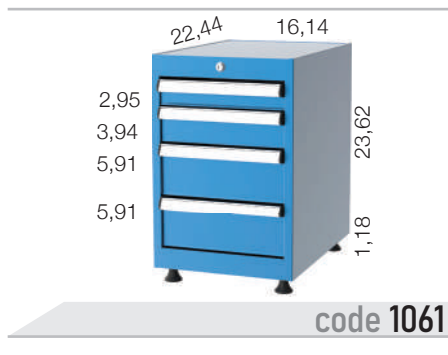
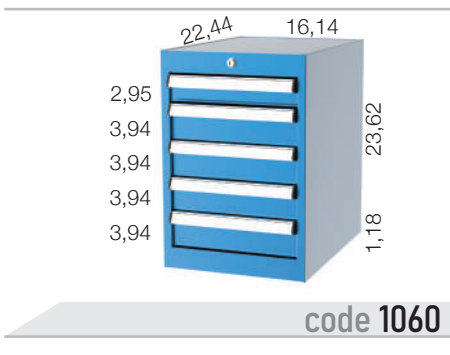
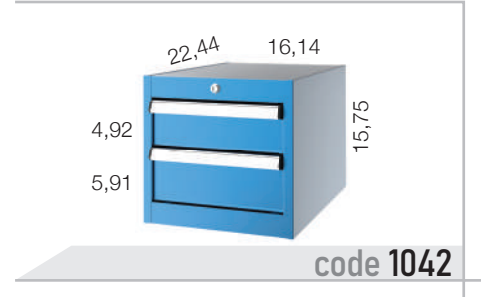
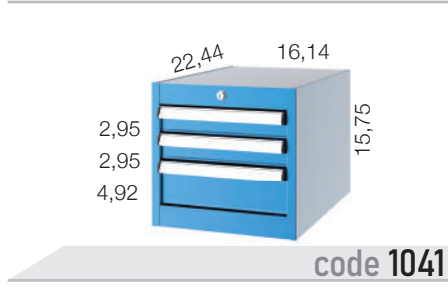
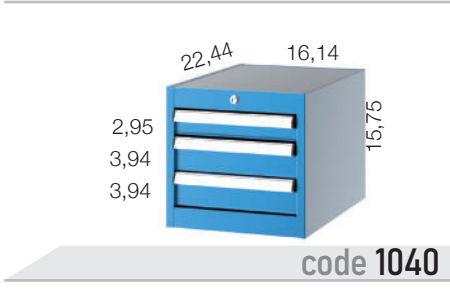
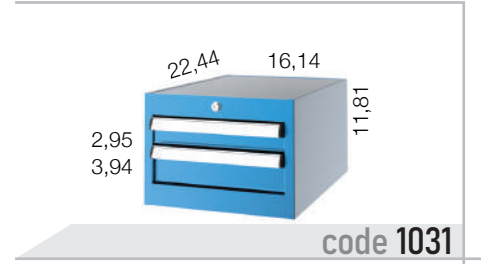
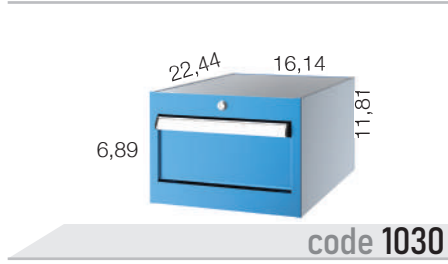

27X27 E

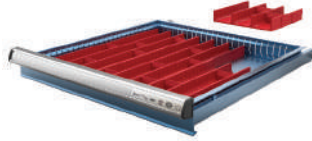
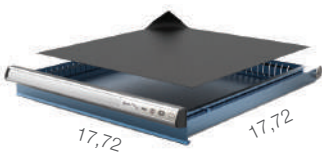

Central Lock



Ball Joint Feet

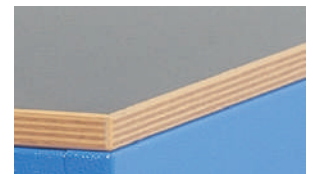

0,71inch MC Chipboard Top



Professional Labelling



Secure Drawer



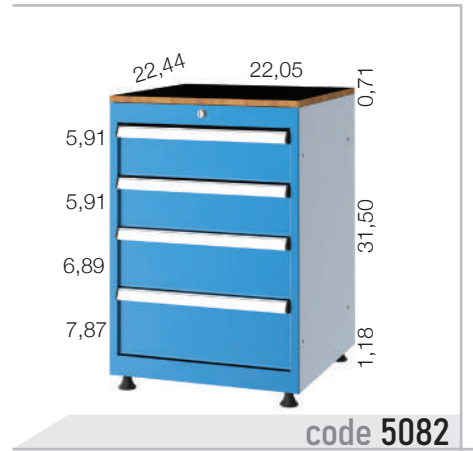
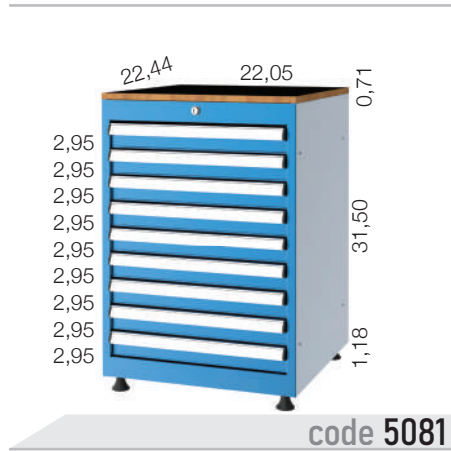
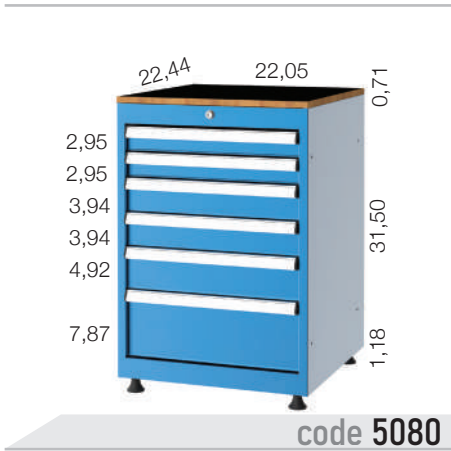
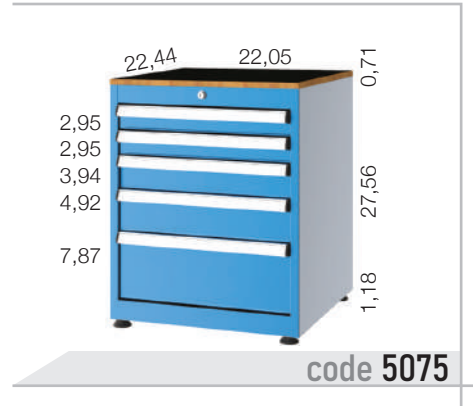
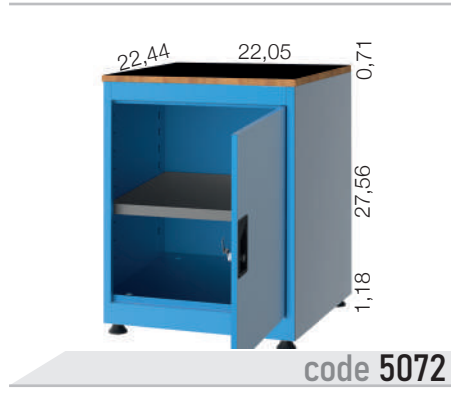
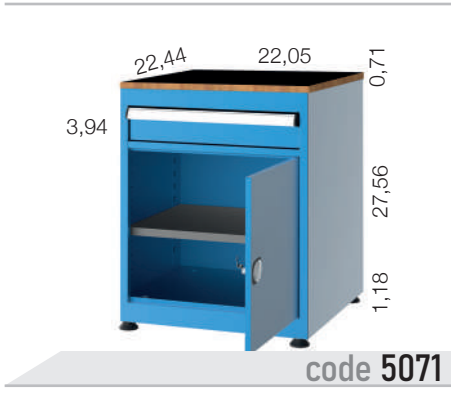
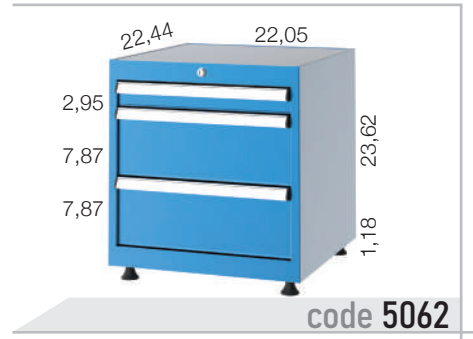
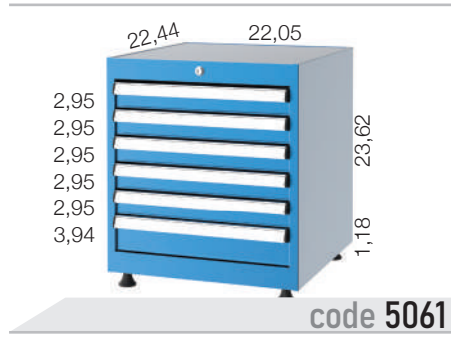
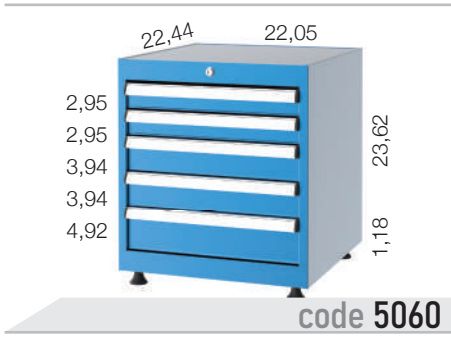
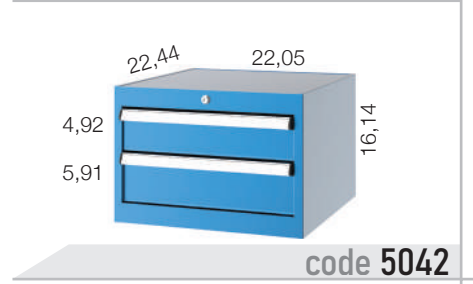
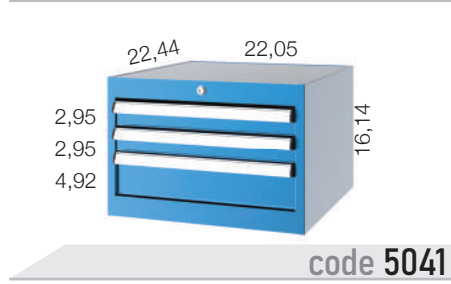
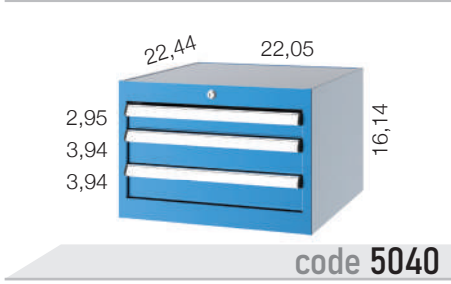
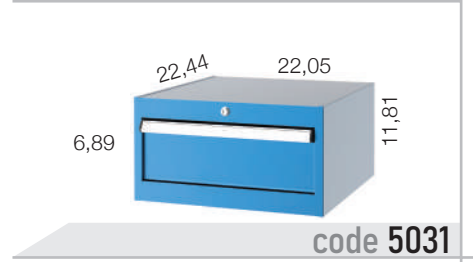
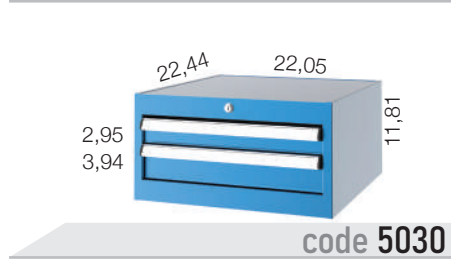

27X27 E

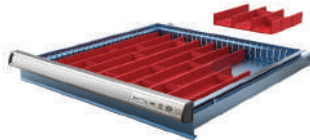
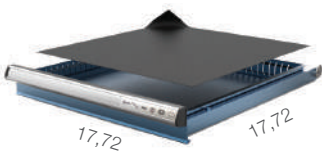

Central Lock



Ball Joint Feet

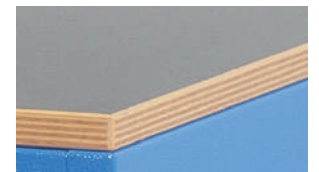

0,71inch MC Chipboard Top



Professional Labelling



Secure Drawer

70,87 inch

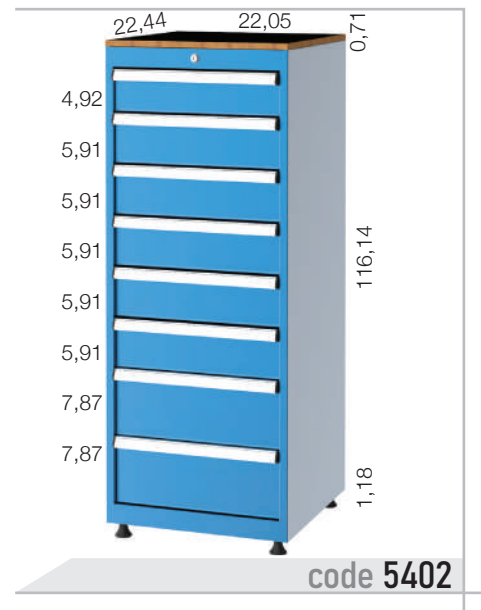
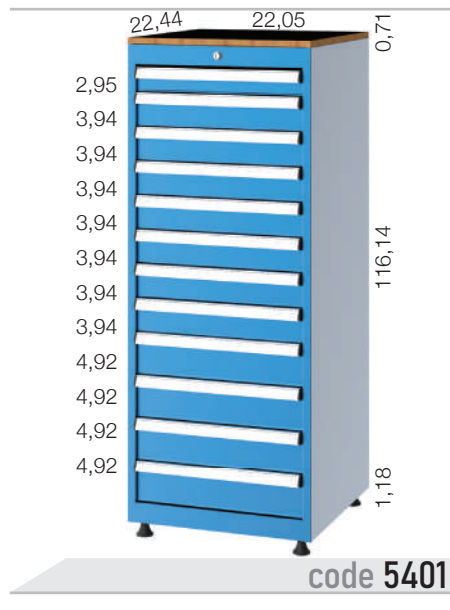
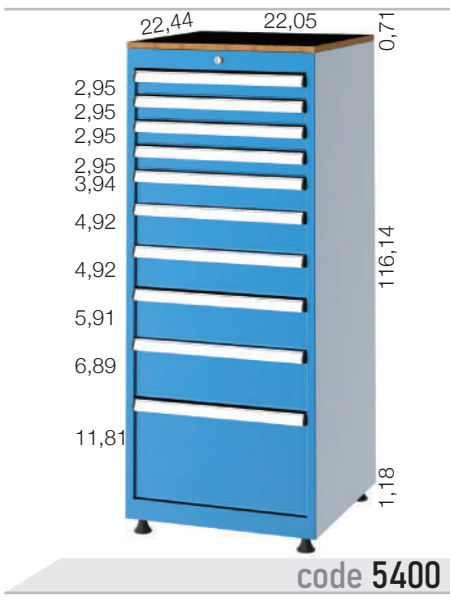
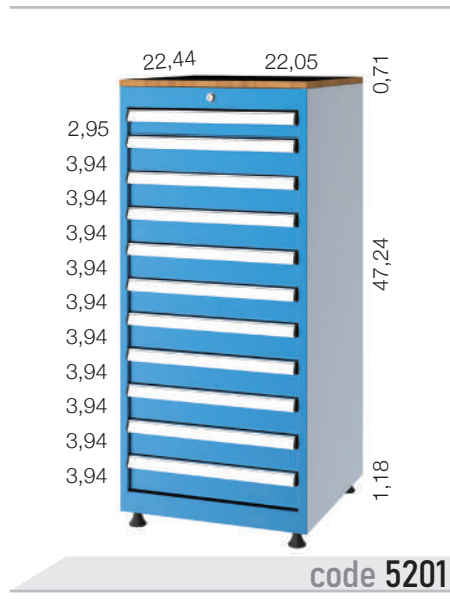
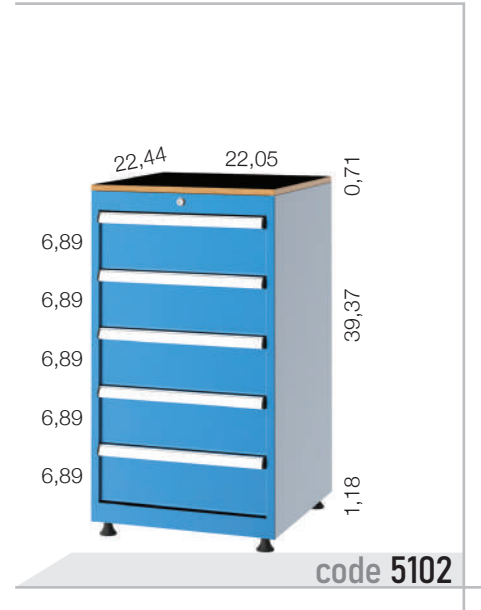
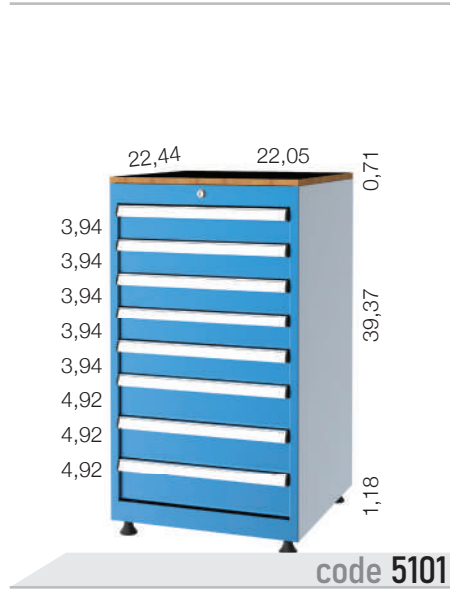
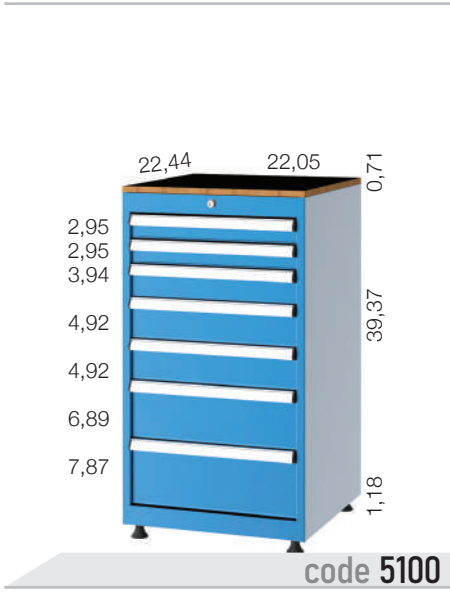

27X36 E

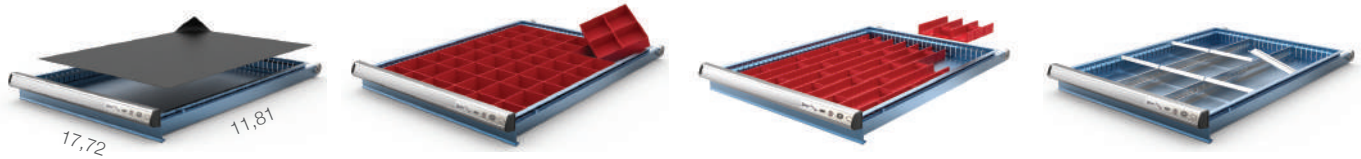

Central Lock



Ball Joint Feet

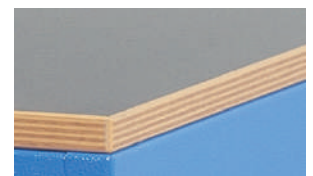

0,71inch MC Chipboard Top



Professional Labelling



Secure Drawer



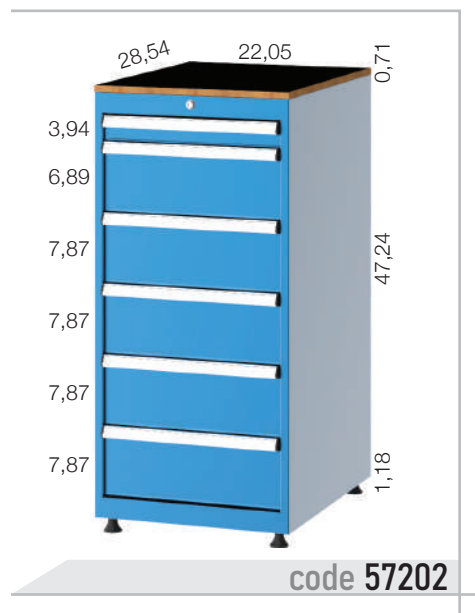
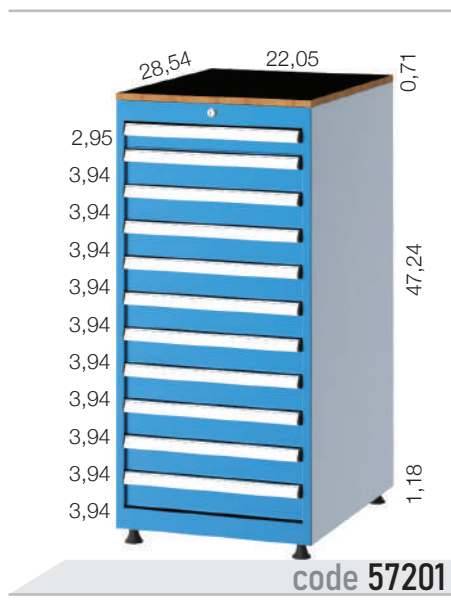
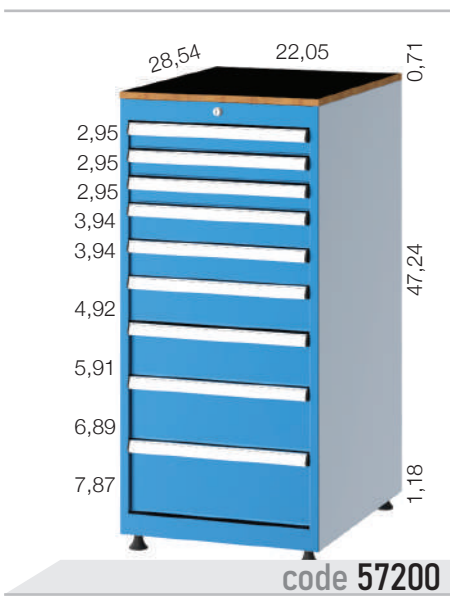
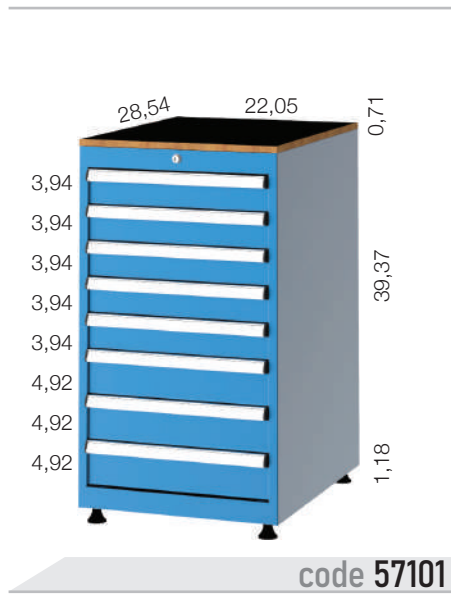
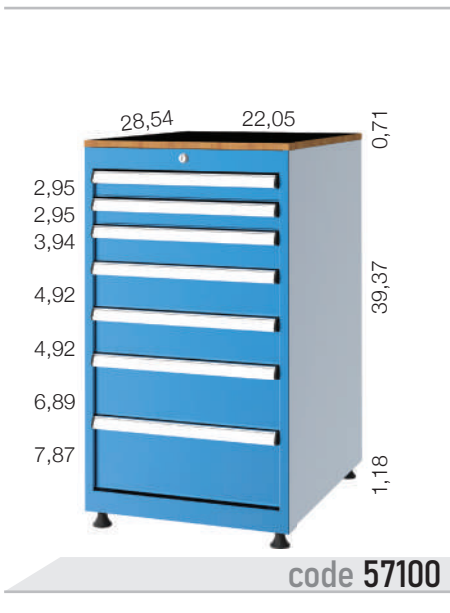

36X27 E

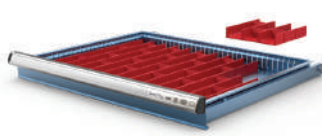
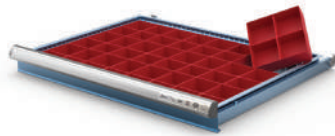

Central Lock



Ball Joint Feet

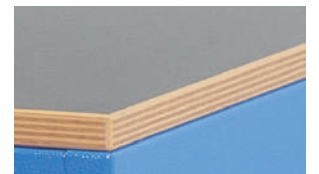

0,71inch MC Chipboard Top



Professional Labelling



Secure Drawer



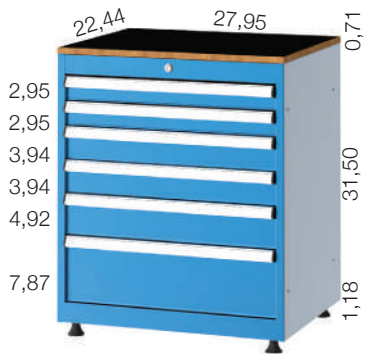

code 75080

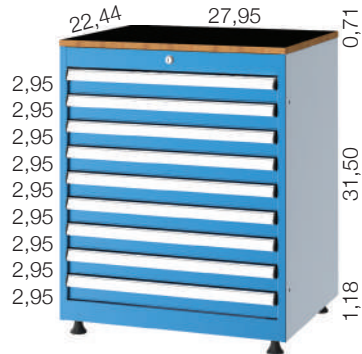

code 75081

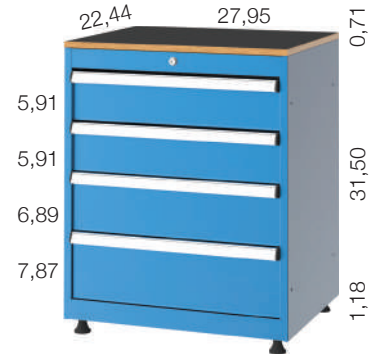

code 75082

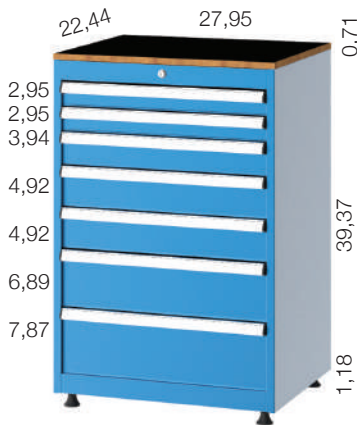

code 75100

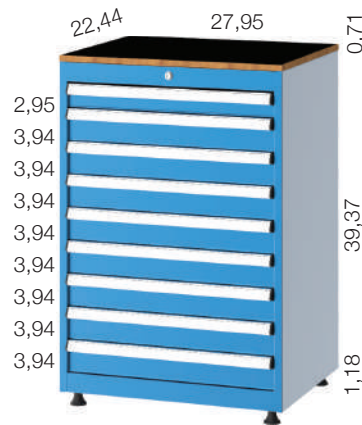

code 75101

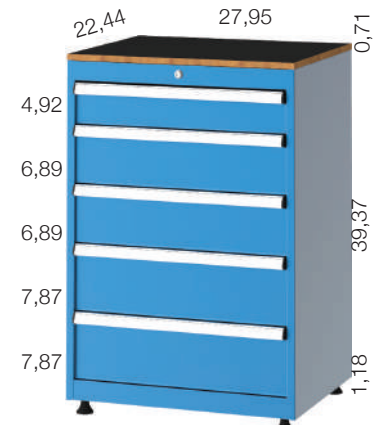

code 75102

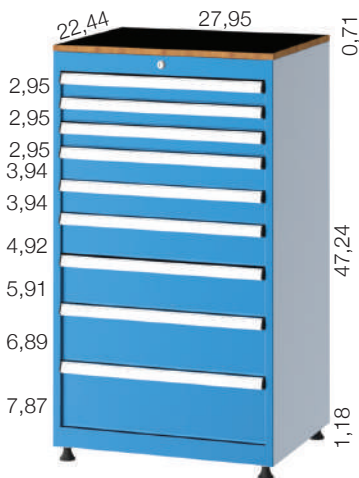

code 75200

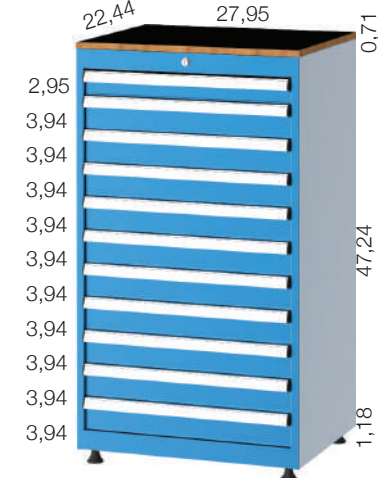

code 75201

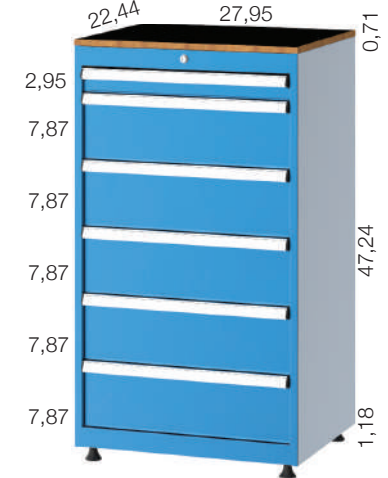

code 75202

36x36 E

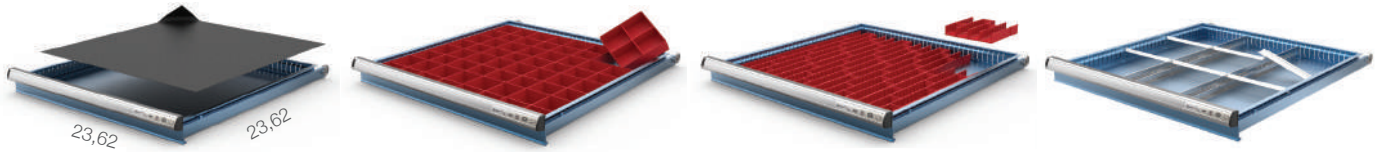

Central Lock



Ball Joint Feet

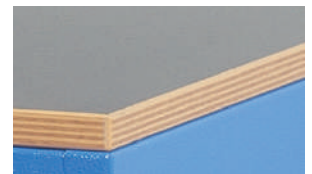

0,71inch MC Chipboard Top



Professional Labelling



Secure Drawer



70,87 inch



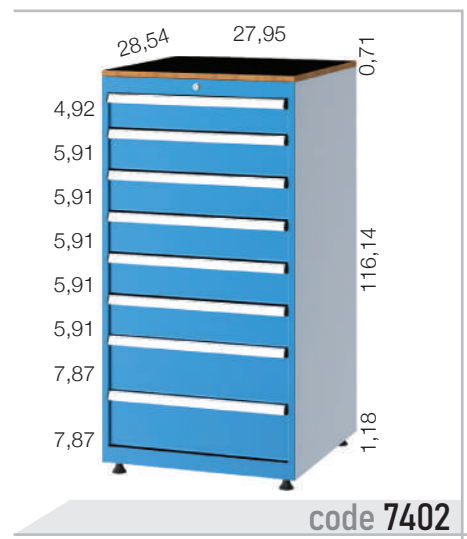
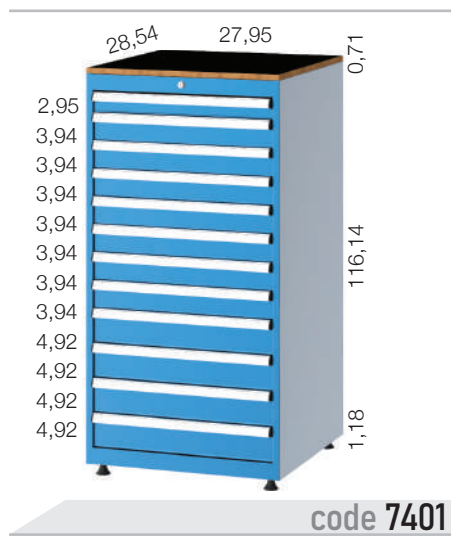
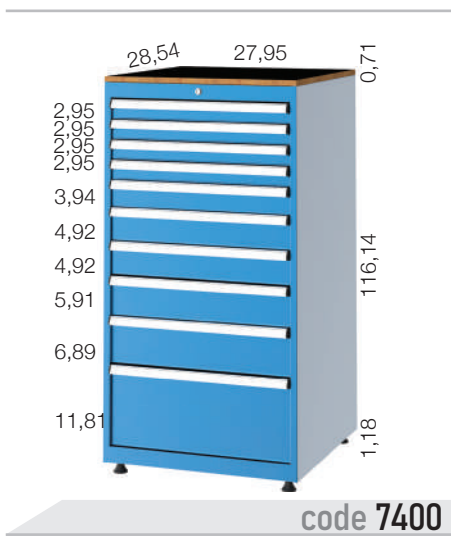
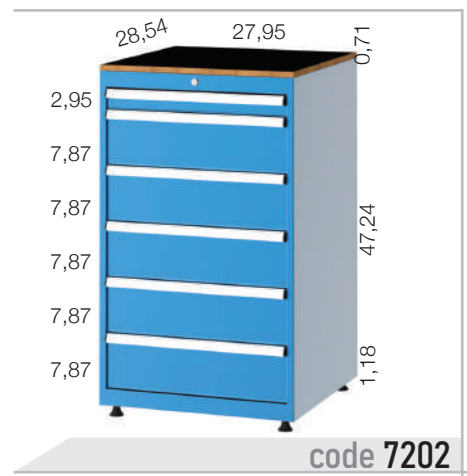
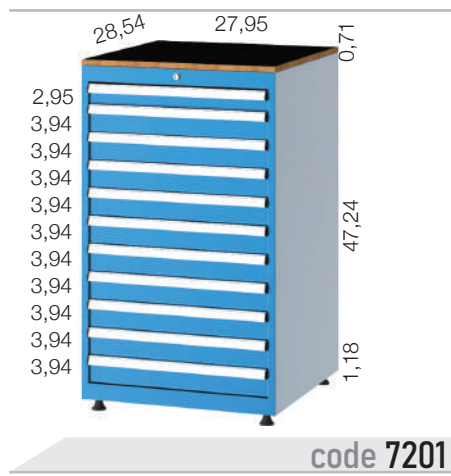
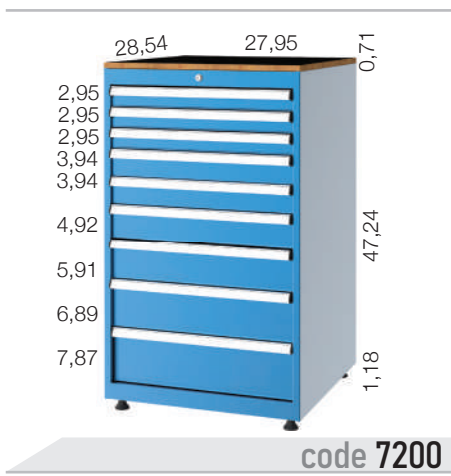
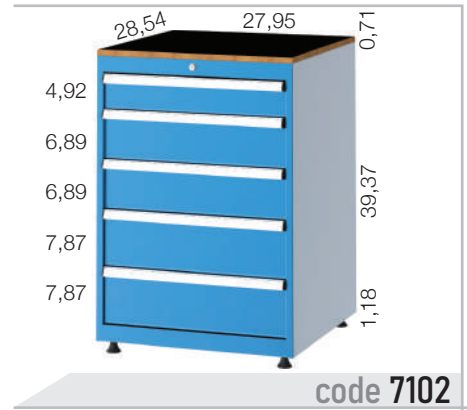
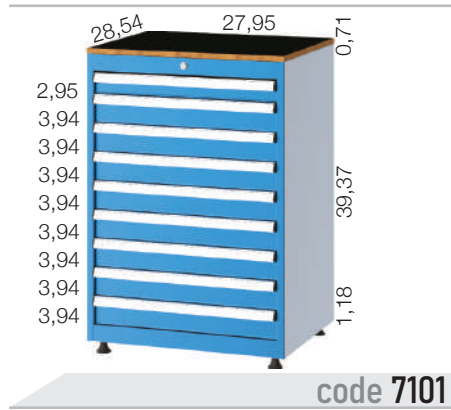
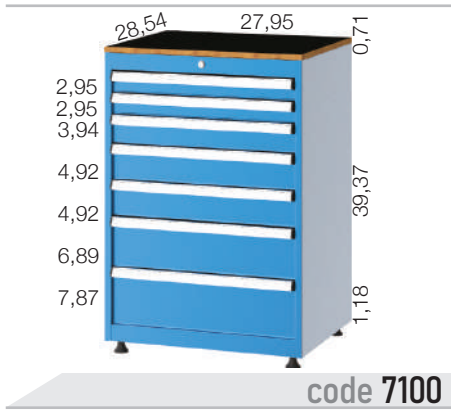
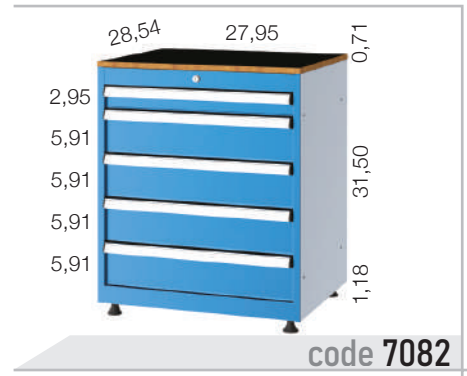
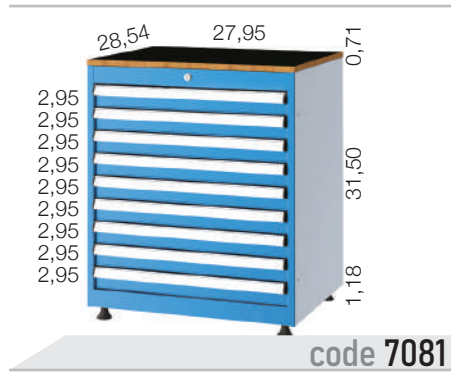
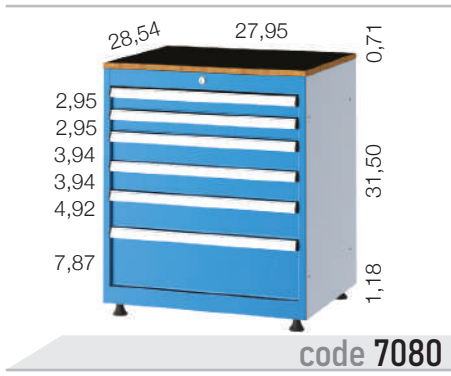

27X54 E



Central Lock



Ball Joint Feet

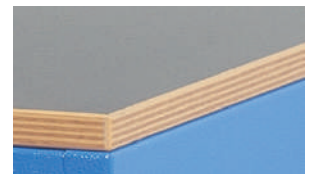

0,71inch MC Chipboard Top



Professional Labelling



Secure Drawer





code 10080

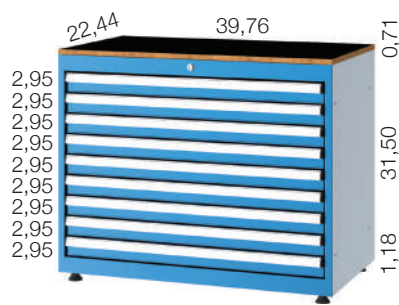

code 10081



code 10082



code 10100

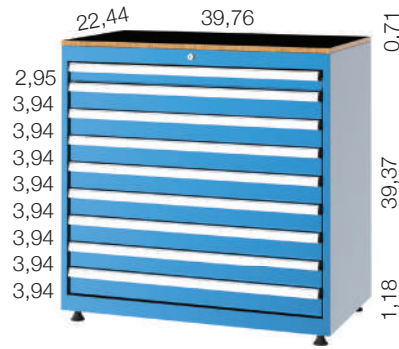

code 10101

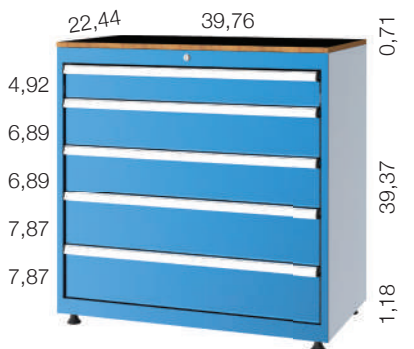

code 10102

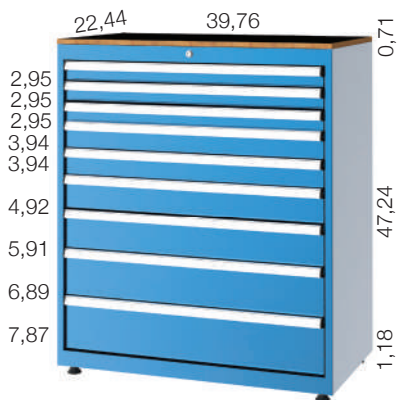

code 10200

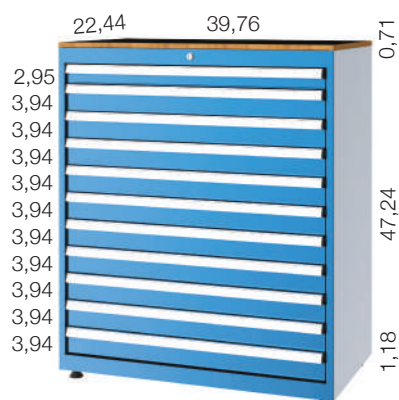

code 10201

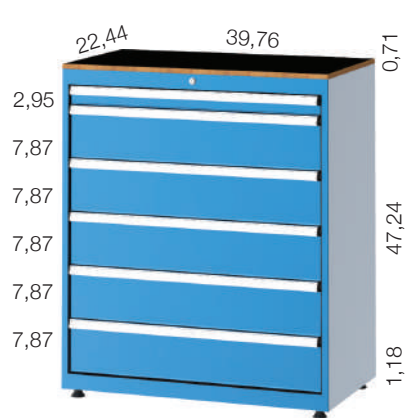

code 10202

36x54 E



Central Lock



Ball Joint Feet

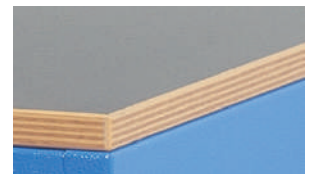

0,71inch MC Chipboard Top



Professional Labelling



Secure Drawer



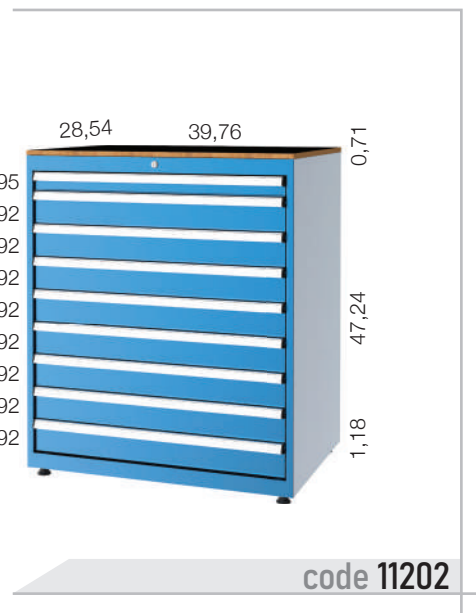
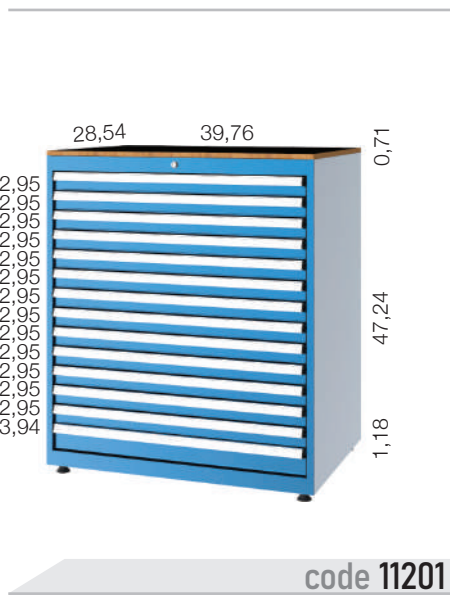
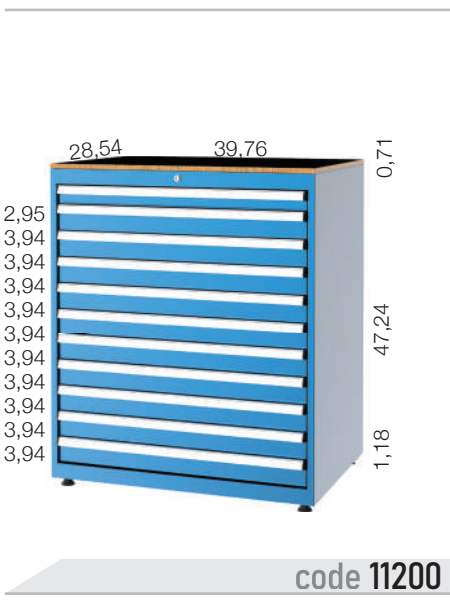
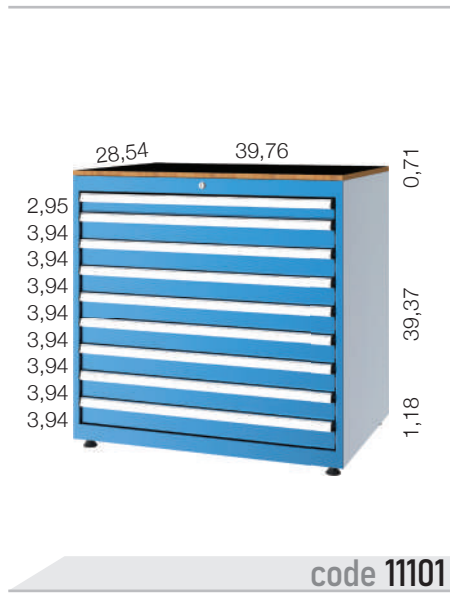
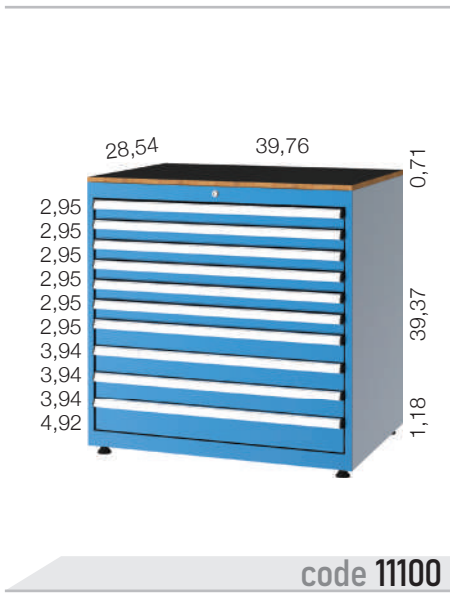
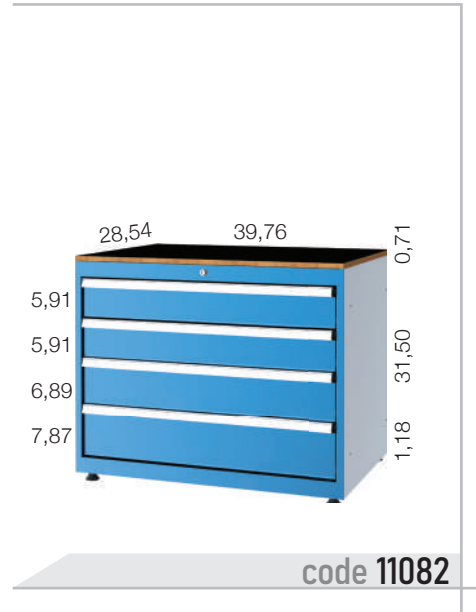
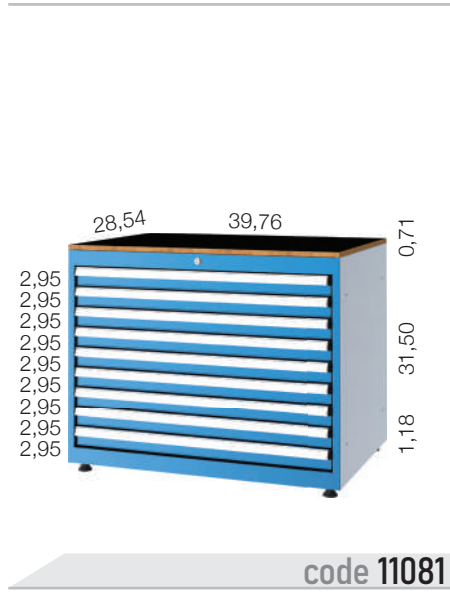
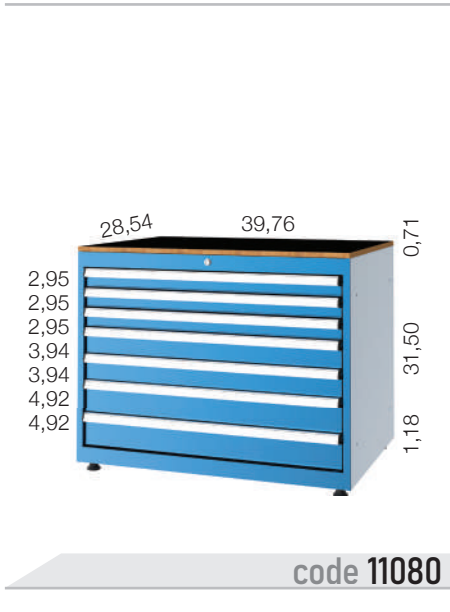

27X54 E

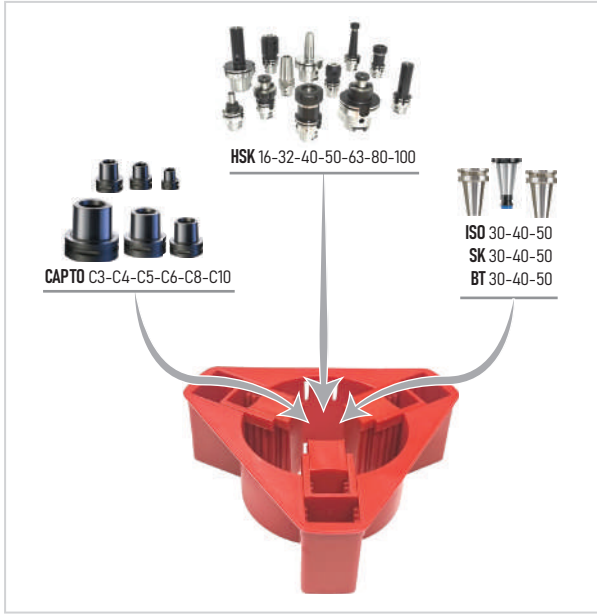

24 pcs CNC holder capacity

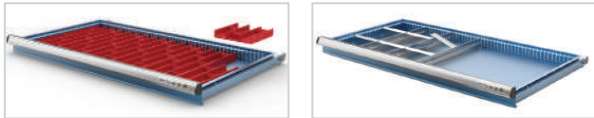

	17,72 17,72	23,62 23,62	17,72 35,43	19,69 11,81 22,44
ISO-SK 30	12	20	24	16
ISO-SK 40	12	20	24	16
ISO-SK 50	12	20	24	16
HSK 16	12	20	24	16
HSK 32	12	20	24	16
HSK 40	12	20	24	16
HSK 50	12	20	24	16
HSK 63	12	20	24	16
HSK 80	12	20	24	16
HSK 100	12	20	24	16
Capto C3	12	20	24	16
Capto C4	12	20	24	16
Capto C5	12	20	24	16
Capto C6	12	20	24	16
Capto C8	12	20	24	16
Capto C10	12	20	24	16



code 2110



code 2115



code 2120



code 2130



code 2140



code 2150



code 2160



code 2170



code 2180

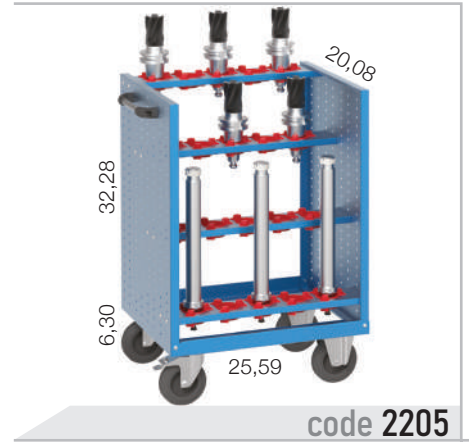
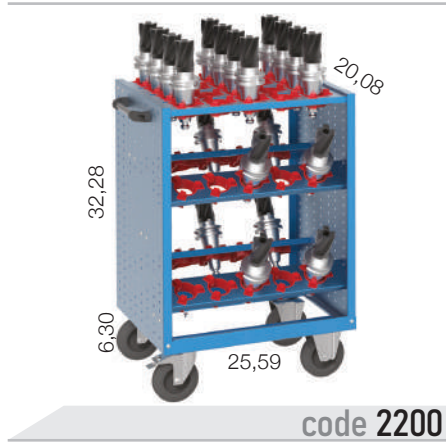

code 2200

code 2205

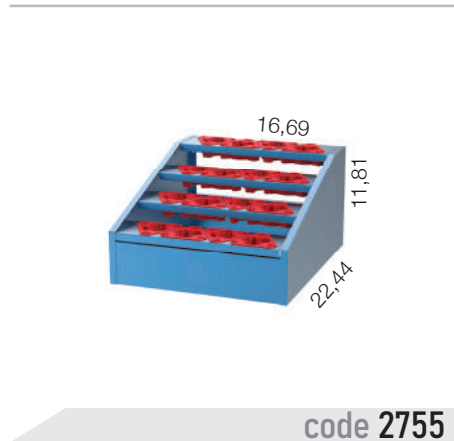

code 2755

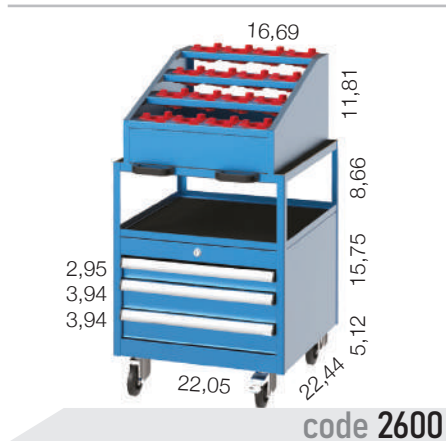

code 2600



code 2730

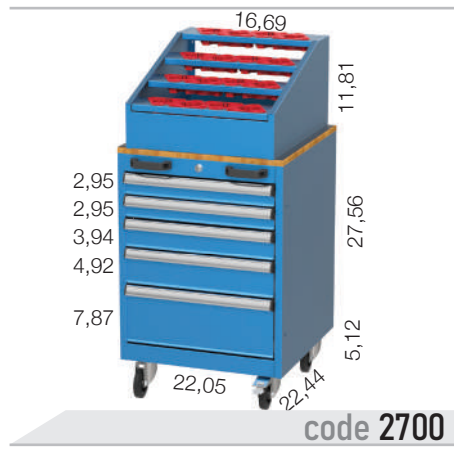

code 2700



code 2750

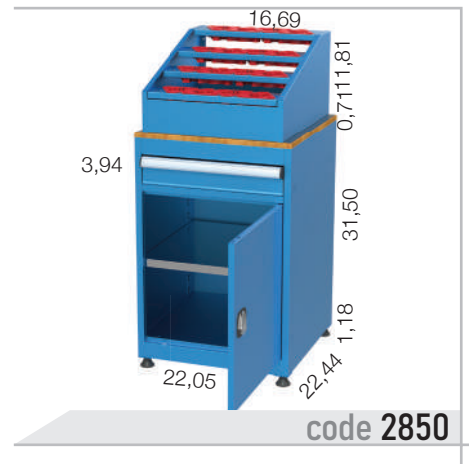

code 2850



code 2630



code 2740

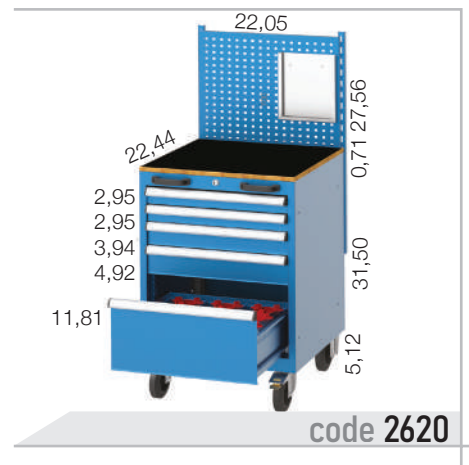

code 2620

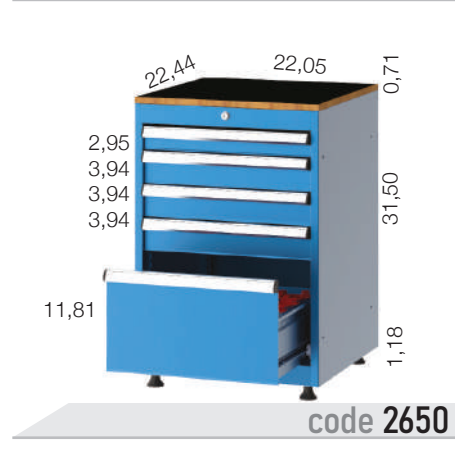



Espagnolette Lock



Latch Lock



Keyboard Elevating Tray

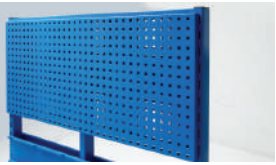

Pegboard

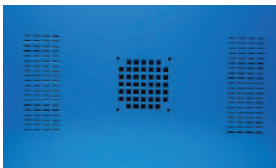

Aeration Area



Wheel*

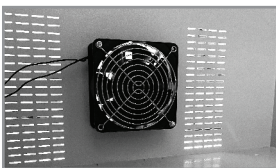

Ventilation*



Sliding Screen Cover

*Optional

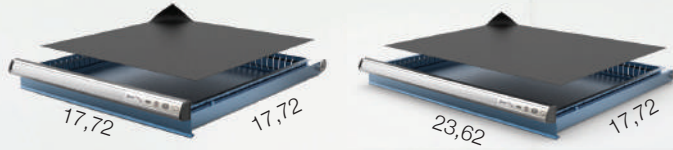

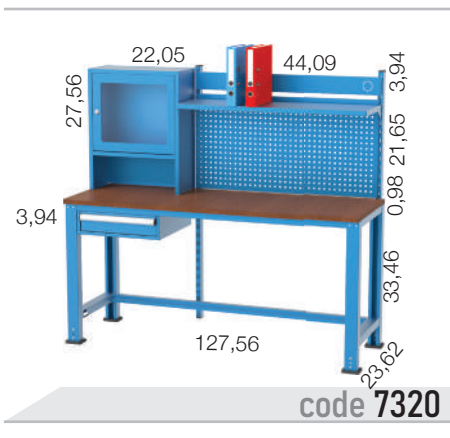
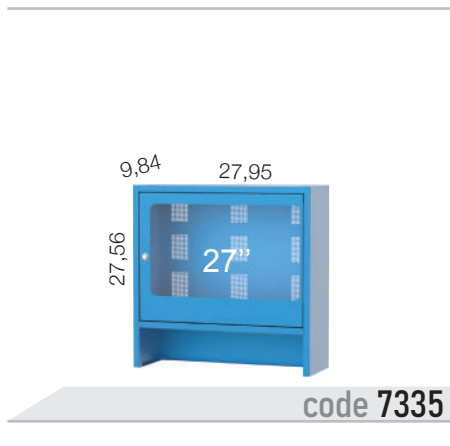
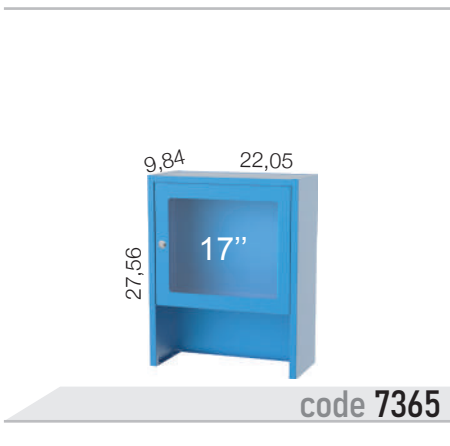
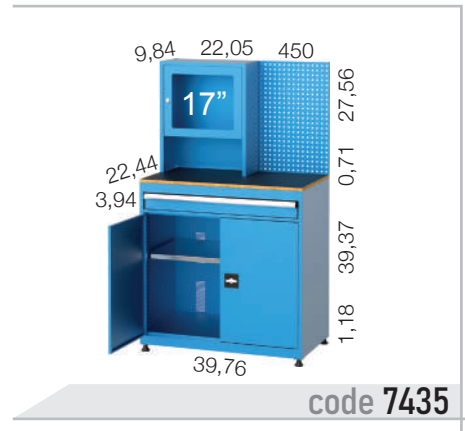
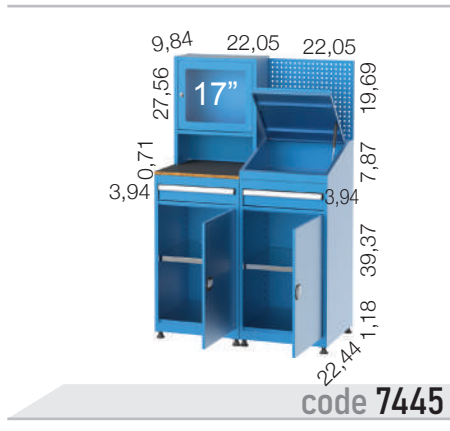
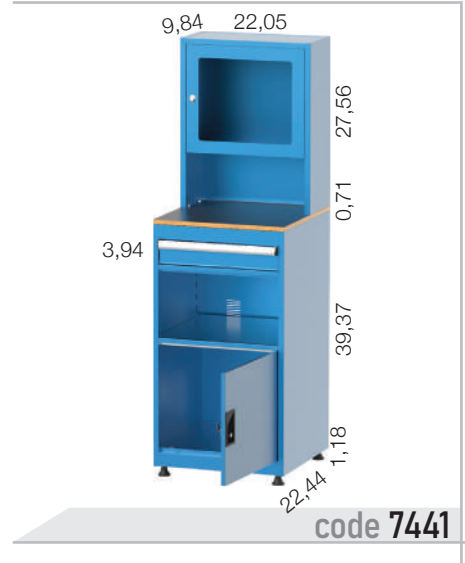

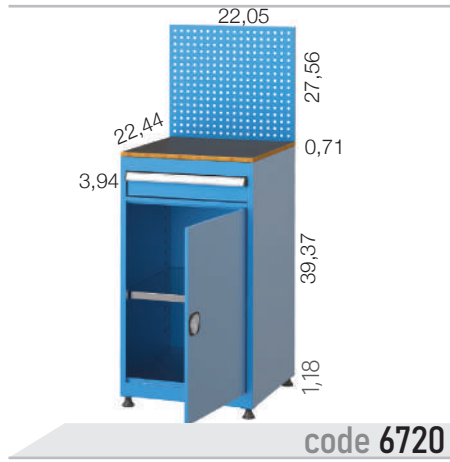



code 6071



code 6074



code 6073



code 6075



code 6077



code 6078



code 6213



code 6214



code 6219

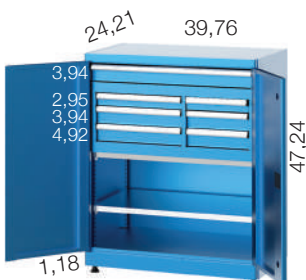

code 6311

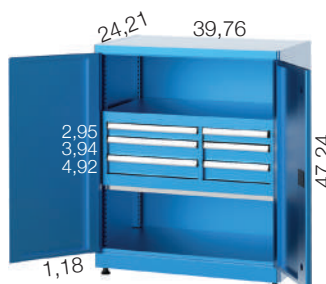

code 6321



code 6316



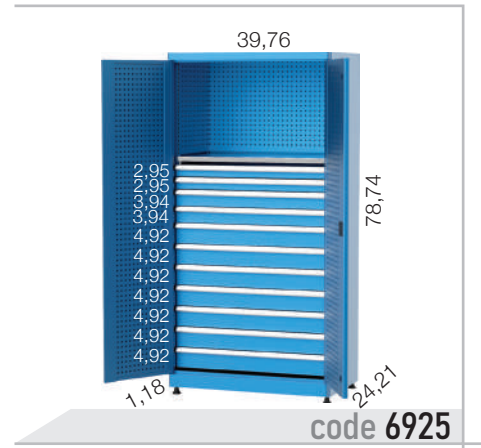
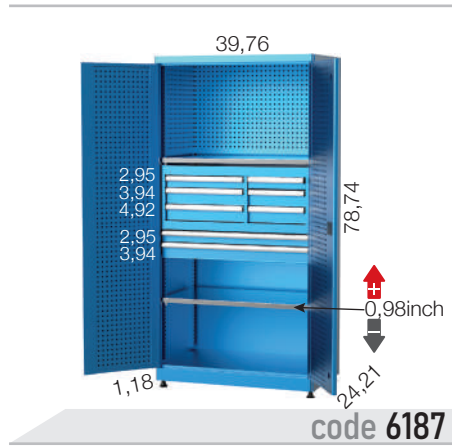
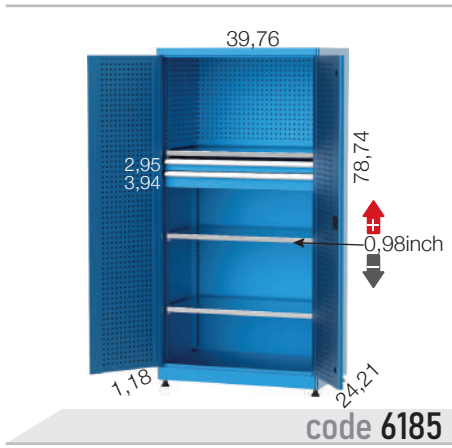
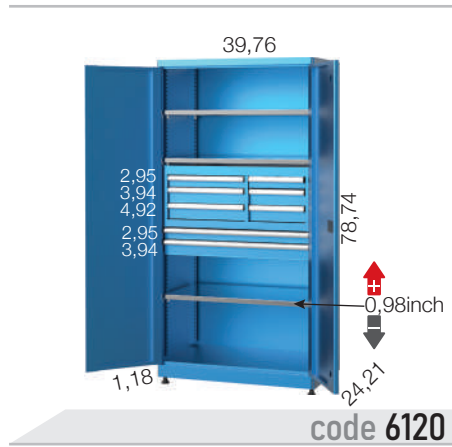
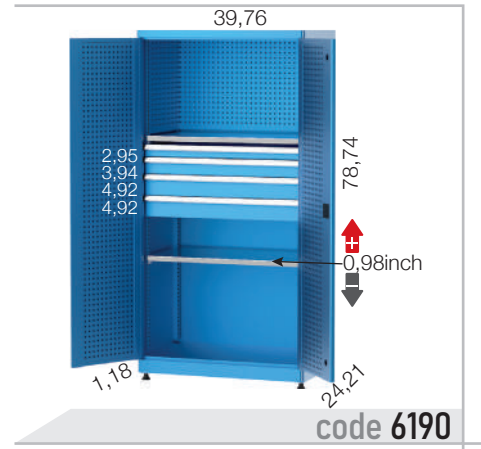
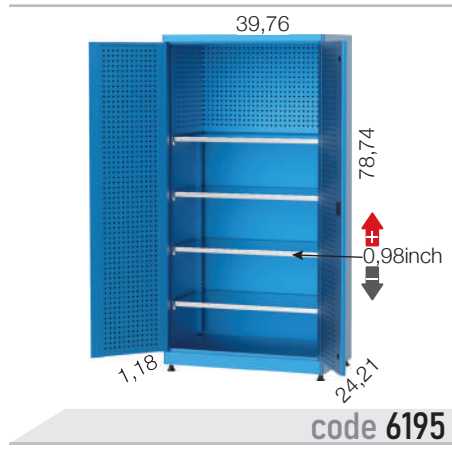

LINBINS



A-100

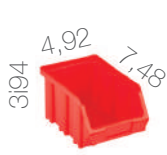

A-150

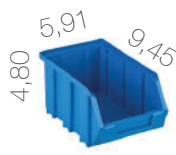

A-200



A-250



A-400

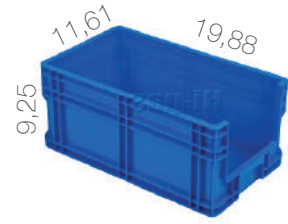

HPAV-27



27x54 E

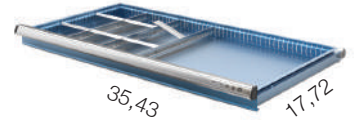

LinBin Shelf



Ball Joint Feet



Espagnolette Lock



Professional Labelling

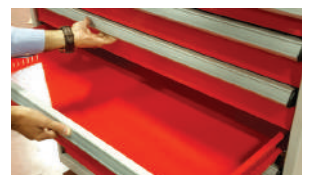

Secure Drawer

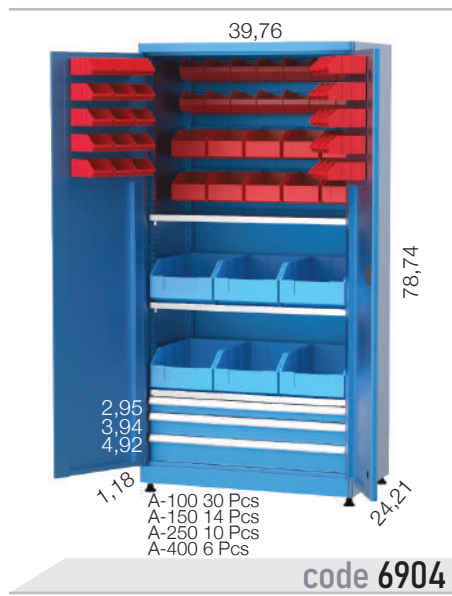
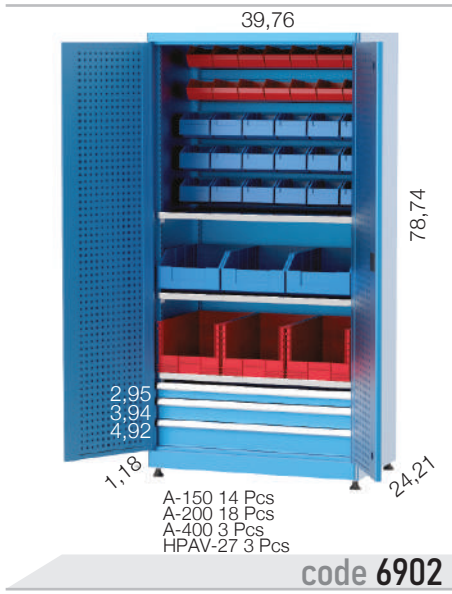



Apart from the fact that our chemical material cabinets are metal, there is no extra heat/fire resistance feature

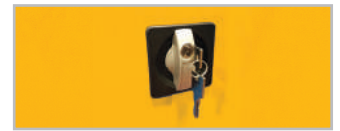

Espagnolette Lock



Galvanized Chemical Pan Shelf



Chemical Aeration

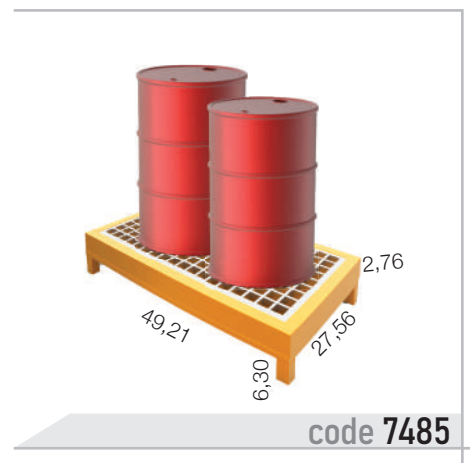



code K25

code K26

code K27

Rifle Barrel Apparatus*

Rifle Grip Apparatus*

Gun Apparatus*

*Accessories are not included and can be ordered separately if needed.

36,22

78,74 code.K25

7,87

17,72

code 7680

36,22

78,74 code.K26

7,87

17,72

code 7610

36,22

78,74 code.K27

7,87

17,72

code 7660



27,56

78,74

3,94

27,56

code.K2
5 Pcs

code.K28
2 Pcs

code 4900

27,56

78,74

3,94

27,56

code.K2
5 Pcs

code 4910



Espagnolette Lock



Ball Joint Feet



code 6150



code 6246

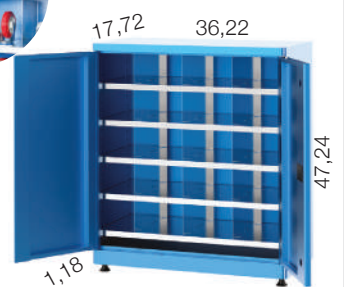

code 6155



code 6228



code 6225



code 6226



code 6235



code 6236



code 6230



code 6231



code 6255



code 6285



HP4322-AV

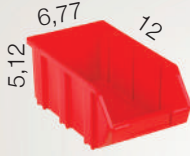

A-250

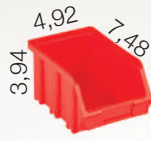

A-150



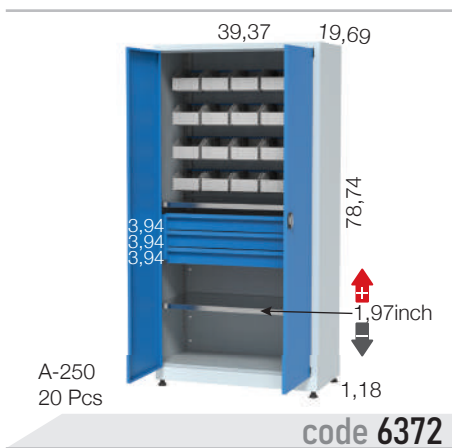
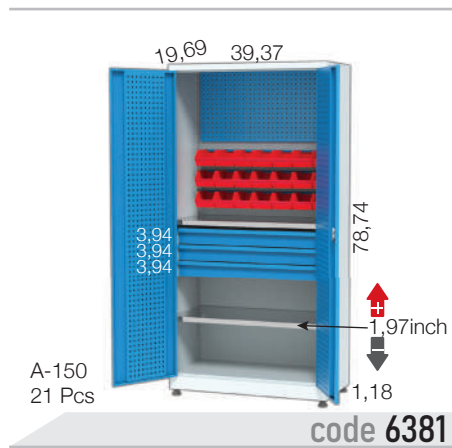
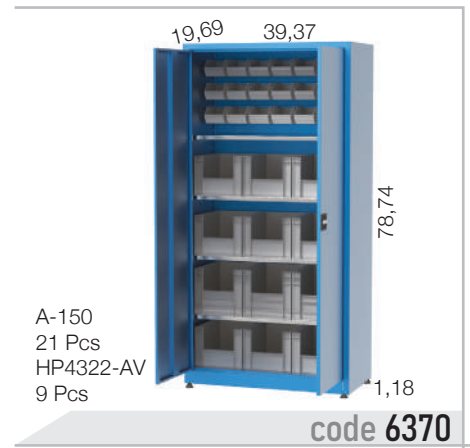
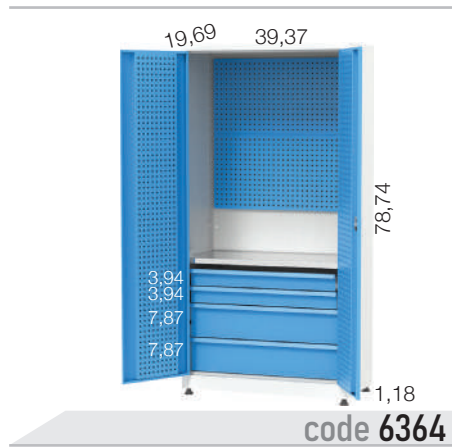
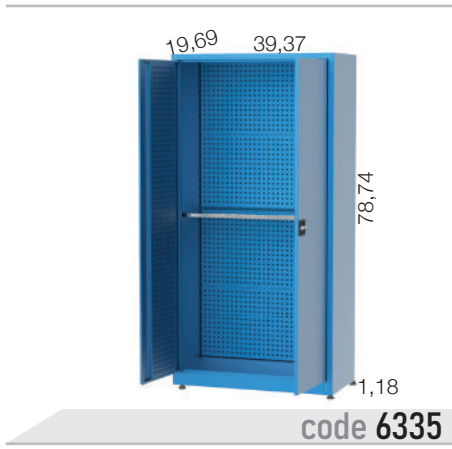

Drawer carrying capacity is maximum 66,14lbs.



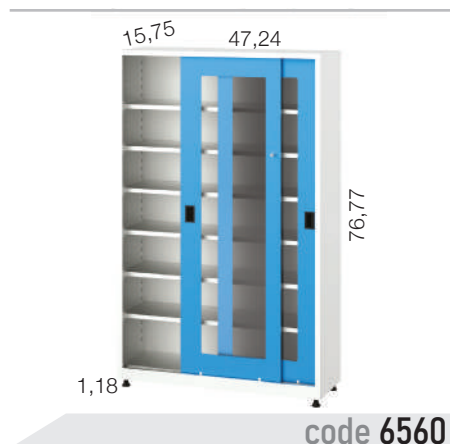
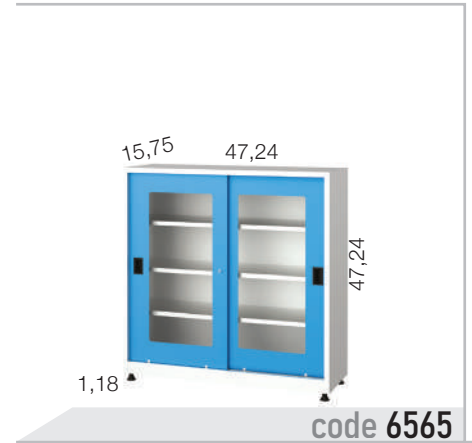
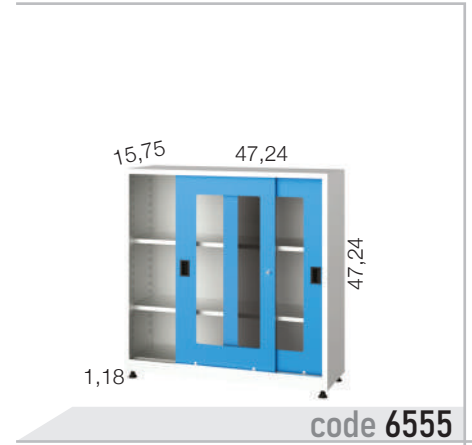



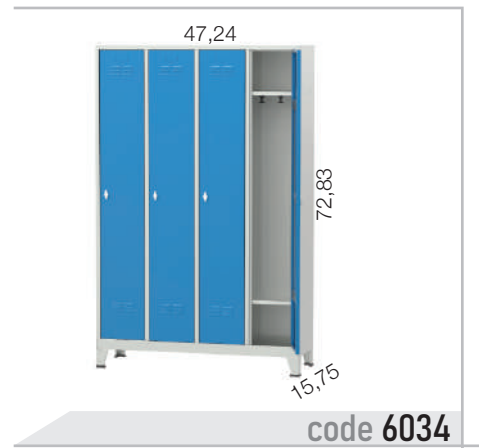
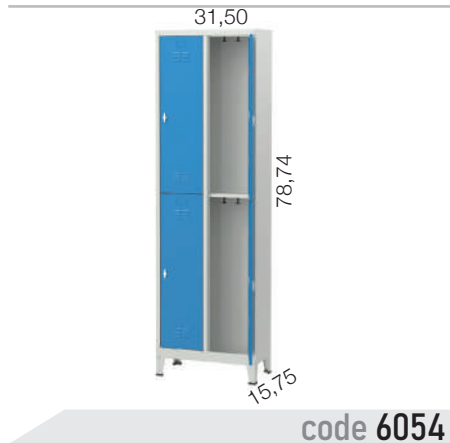



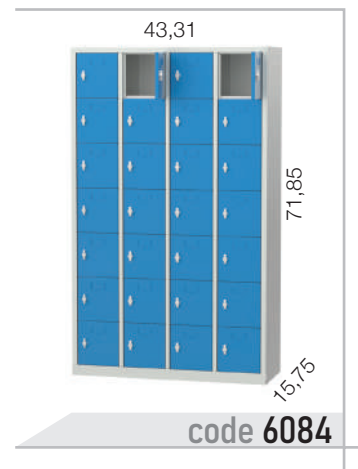
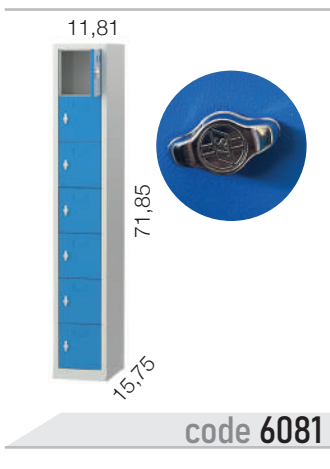
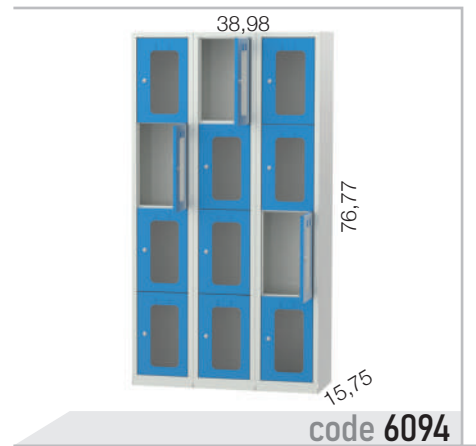
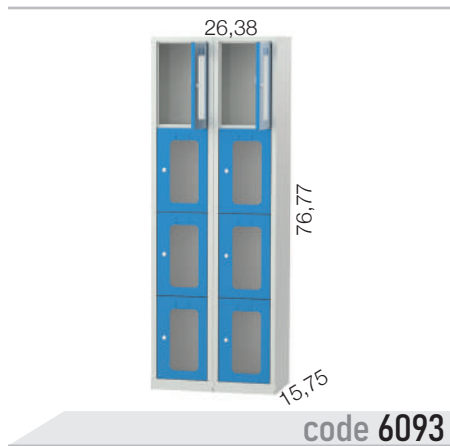
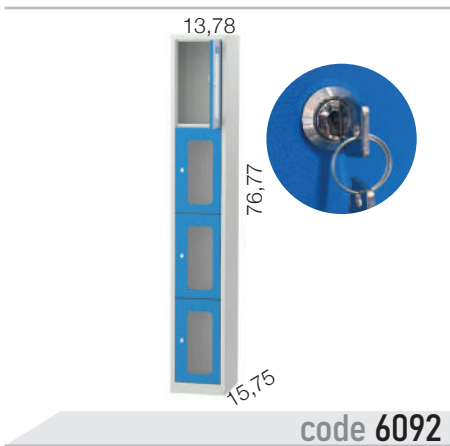
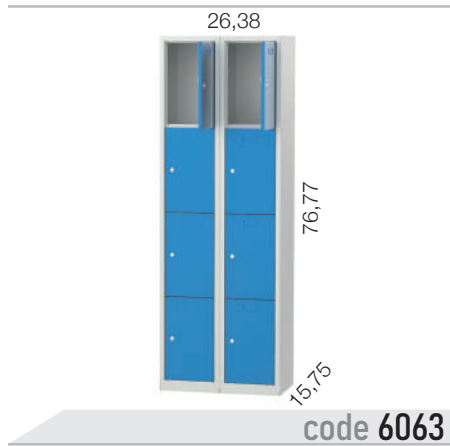
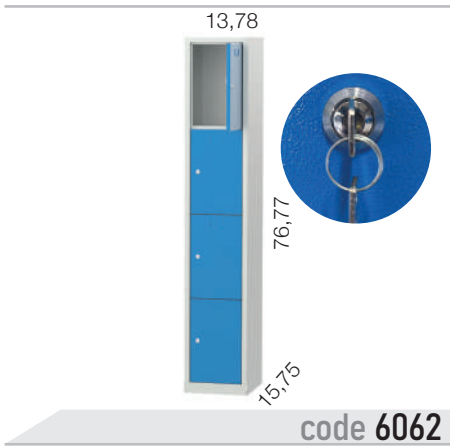
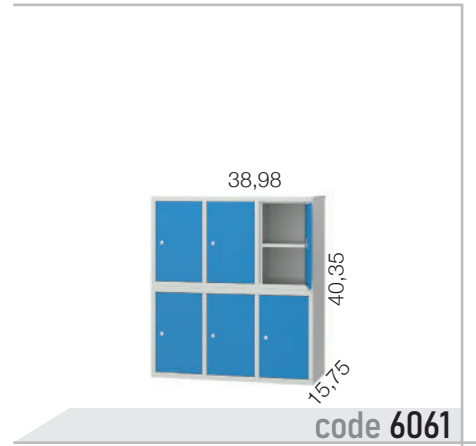

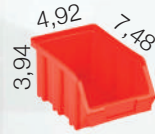

A-150



A-200



A-250

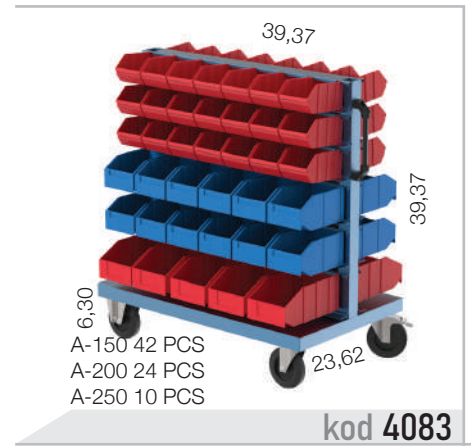
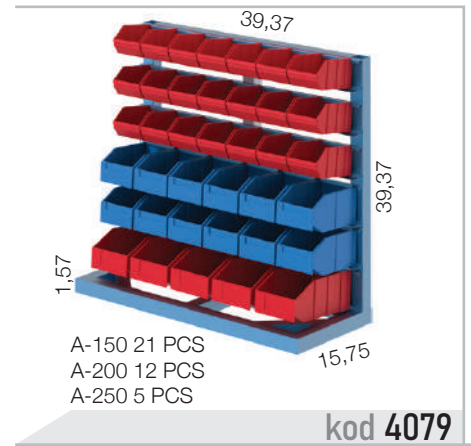
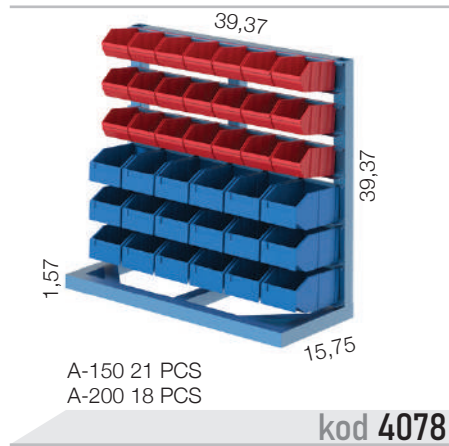
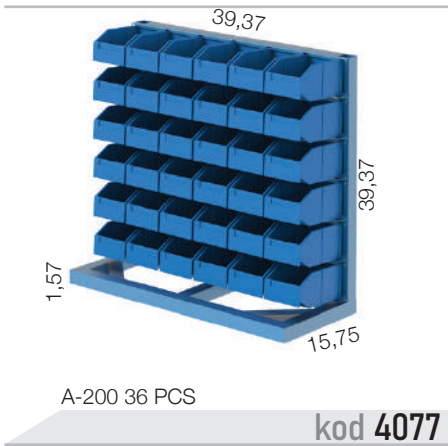

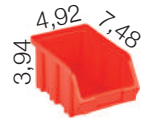

A-150



A-200

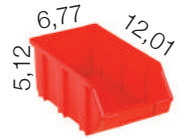

A-250

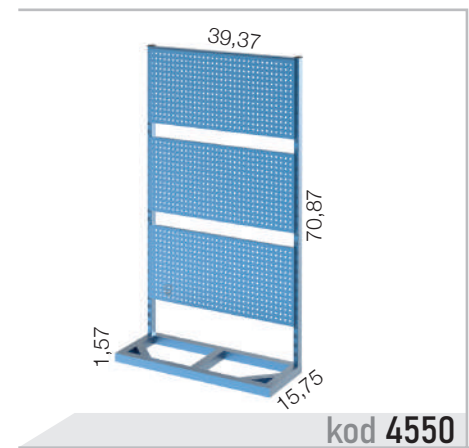
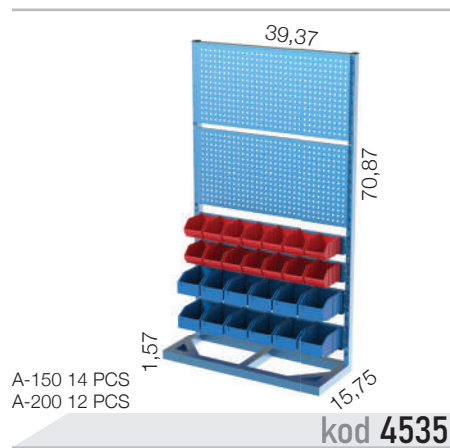
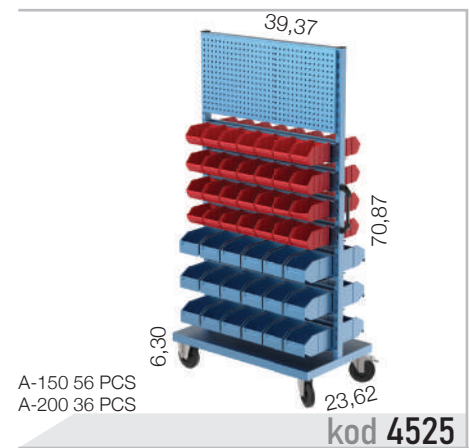
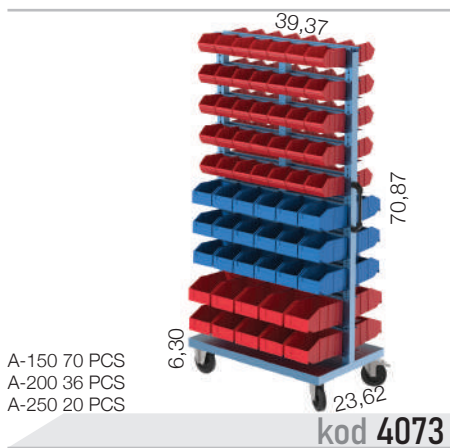
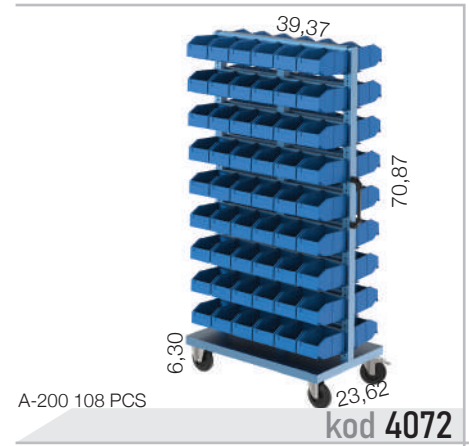
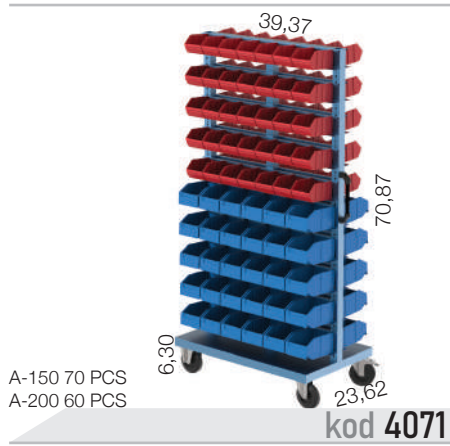
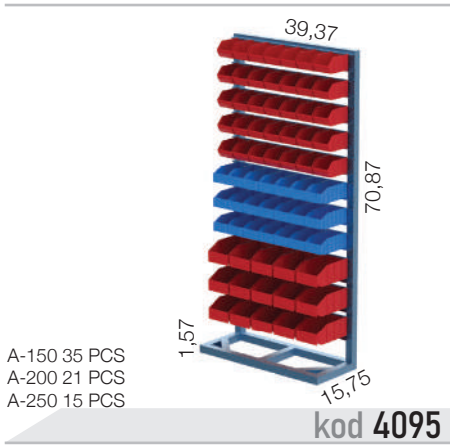
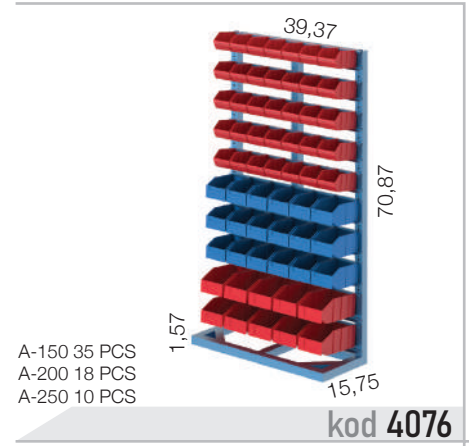
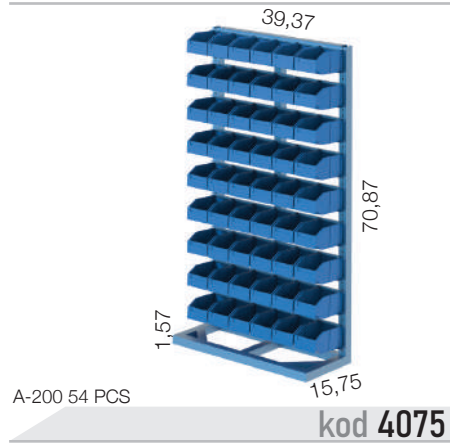
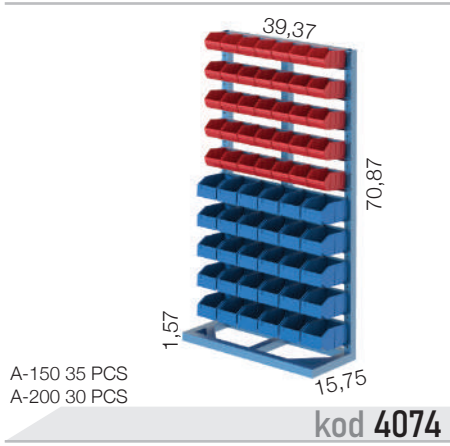



A-150



A-250



A-300

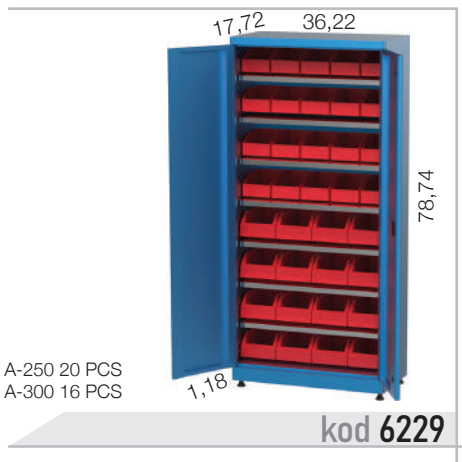
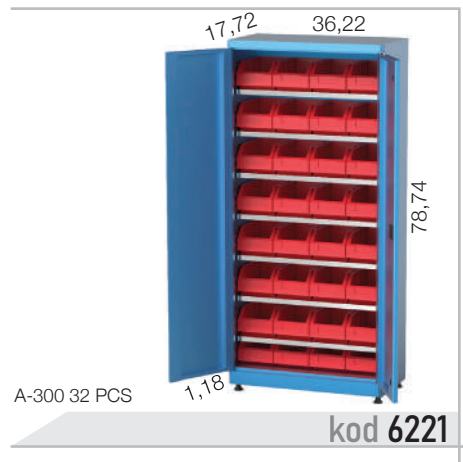
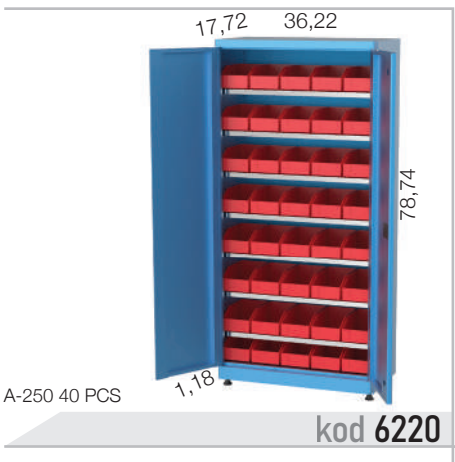





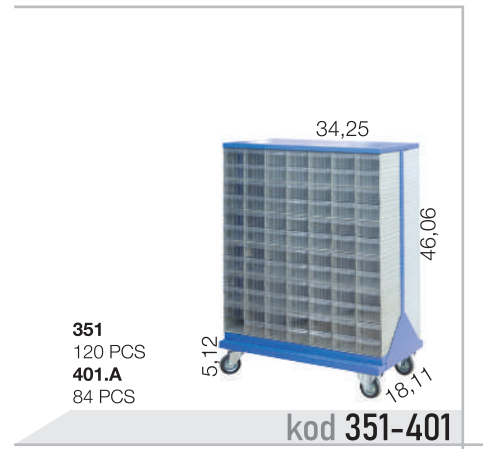
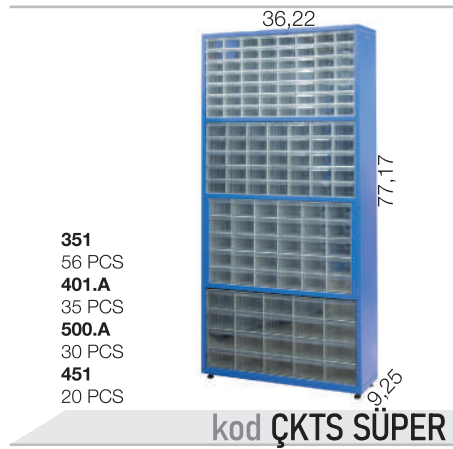
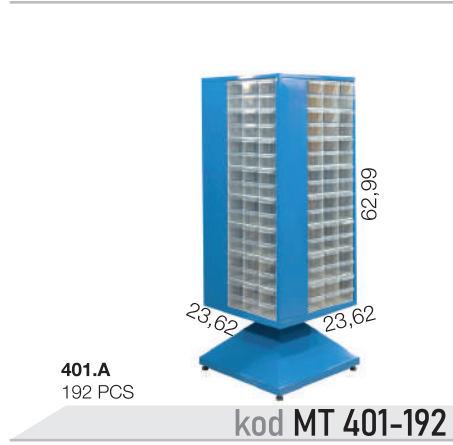
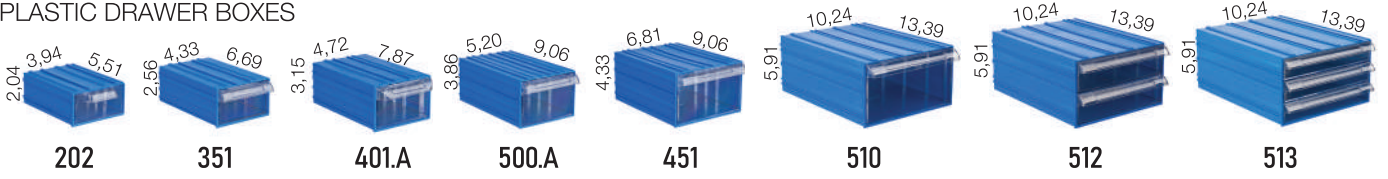





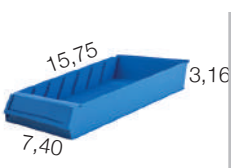
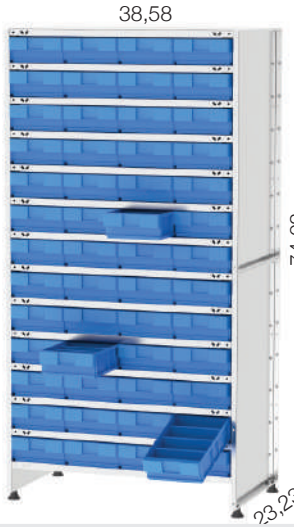



PLASTIC DRAWER BOXES





 <p>23,62 3,94 9,06</p> <p>kod SV619</p>	 <p>23,62 3,94 4,53</p> <p>kod SV609</p>	 <p>15,75 3,16 7,40</p> <p>kod SV419</p>	 <p>38,58 74,02 23,23</p> <p>SV-619 52 PCS SV-619B 260 PCS</p> <p>kod 592-619</p>
 <p>15,75 3,16 3,54</p> <p>kod SV409</p>	 <p>11,81 3,16 7,40</p> <p>kod SV319</p>	 <p>11,81 3,16 3,54</p> <p>kod SV309</p>	
<p>Separator</p>  <p>kod SV619 B</p>	<p>Separator</p>  <p>kod SV609 B</p>	<p>Separator</p>  <p>kod SV419B</p>	
<p>Separator</p>  <p>kod SV409B</p>	<p>Separator</p>  <p>kod SV319B</p>	<p>Separator</p>  <p>kod SV309B</p>	

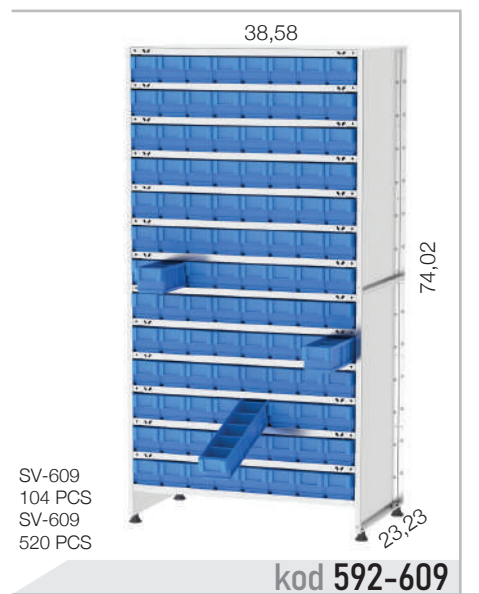
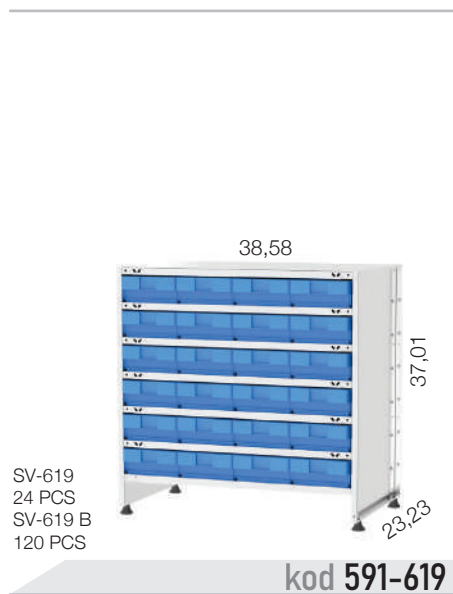
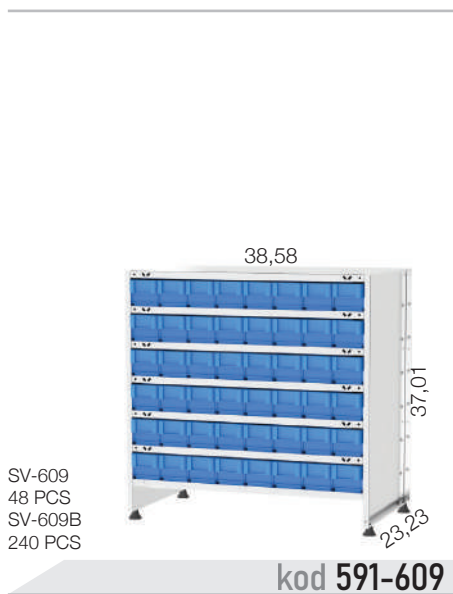
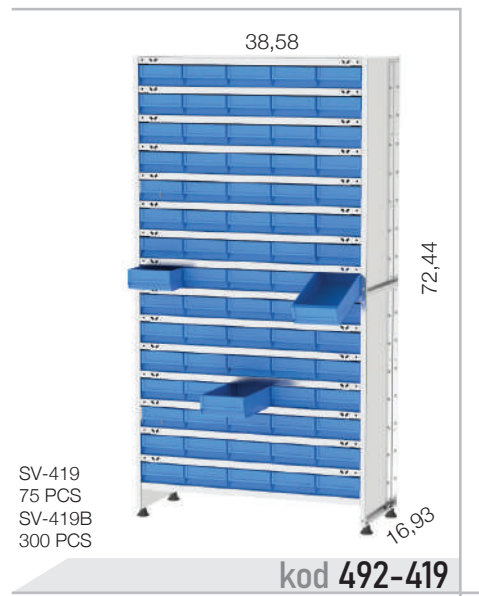
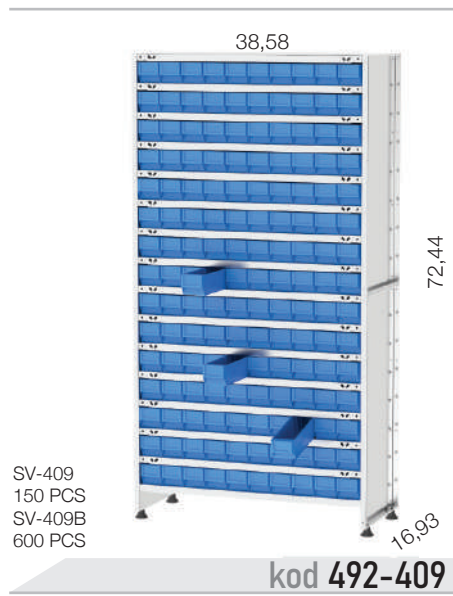
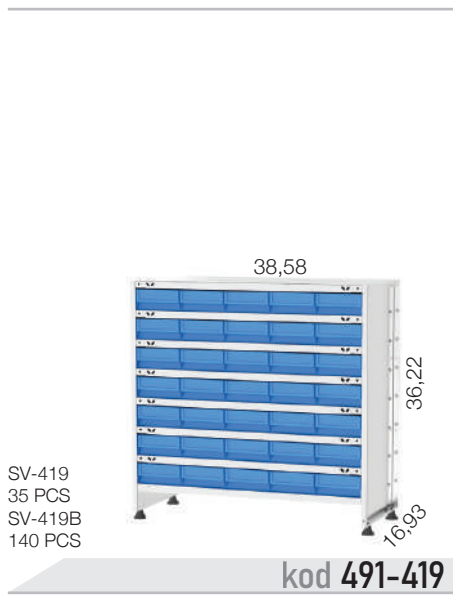
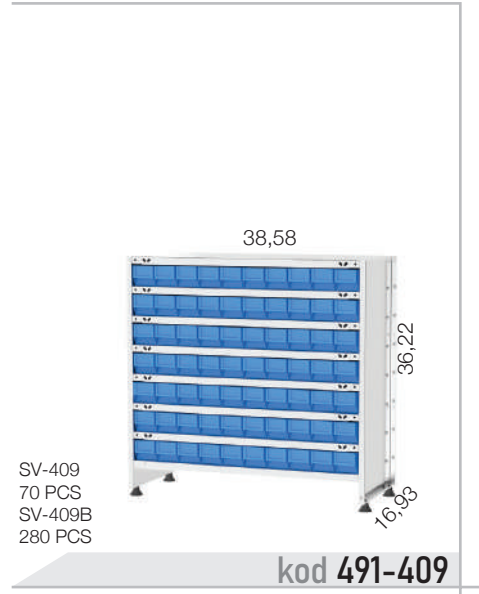
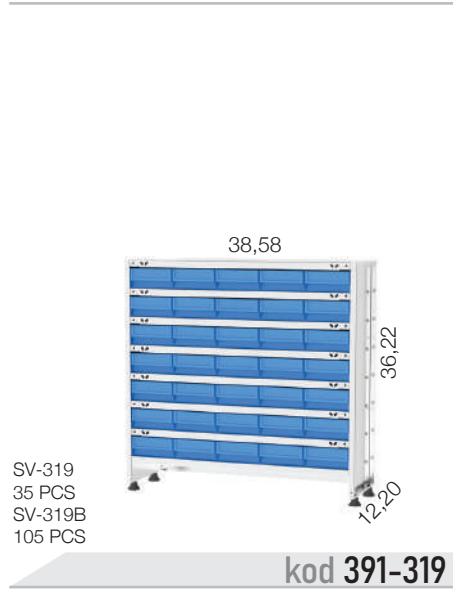
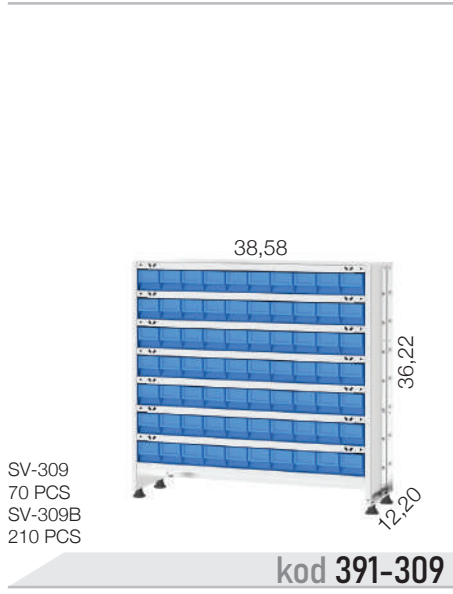



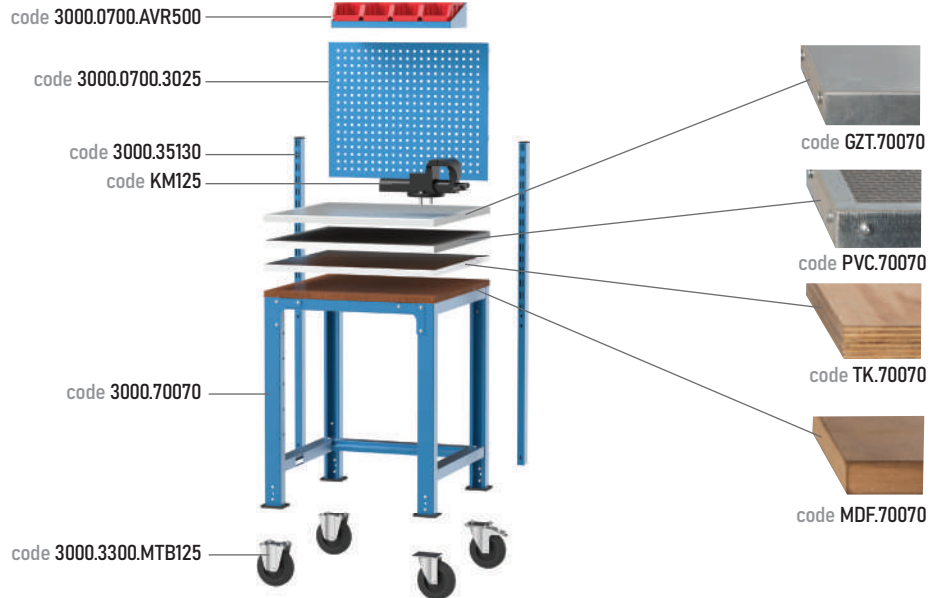

KOCEL

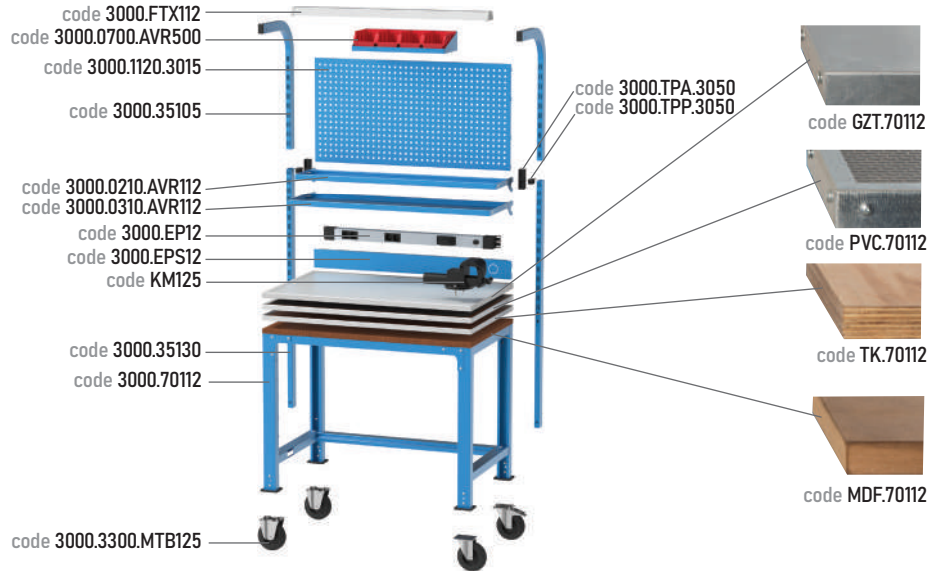

KOCEL

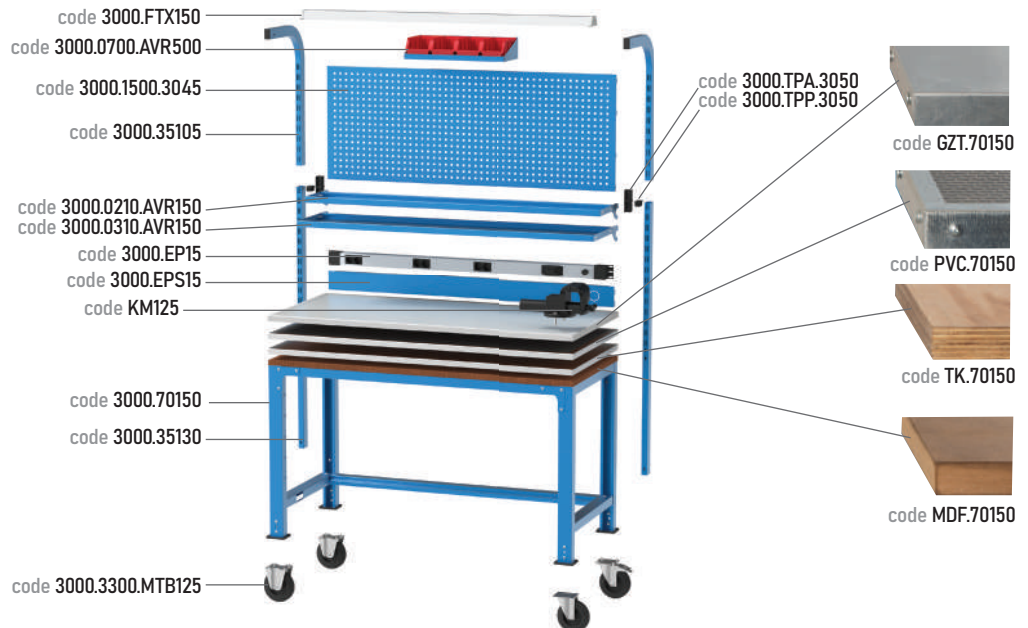

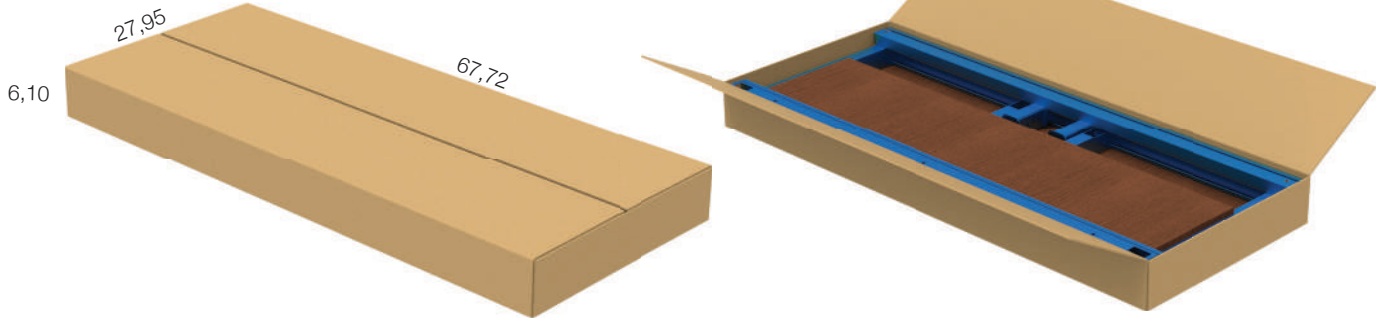
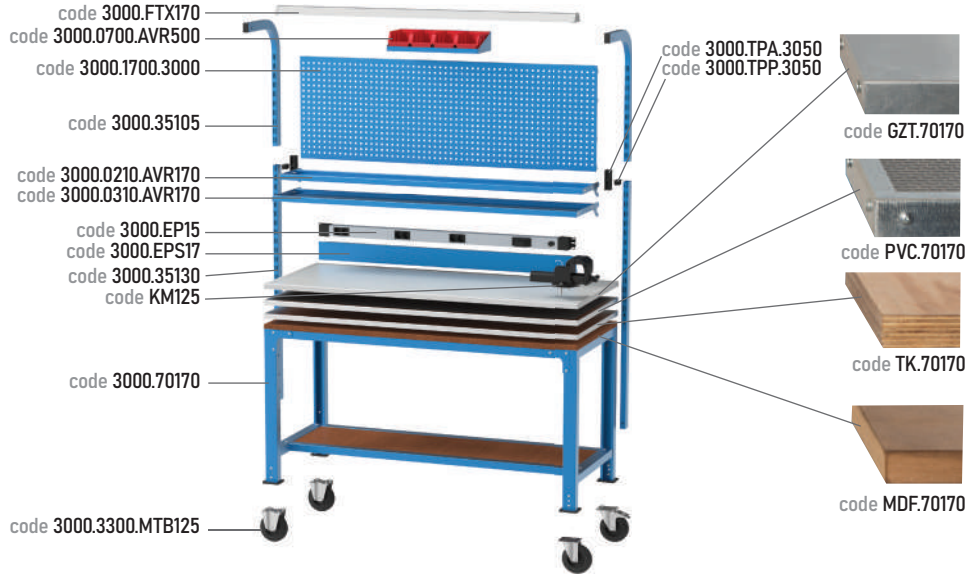

KOCEL

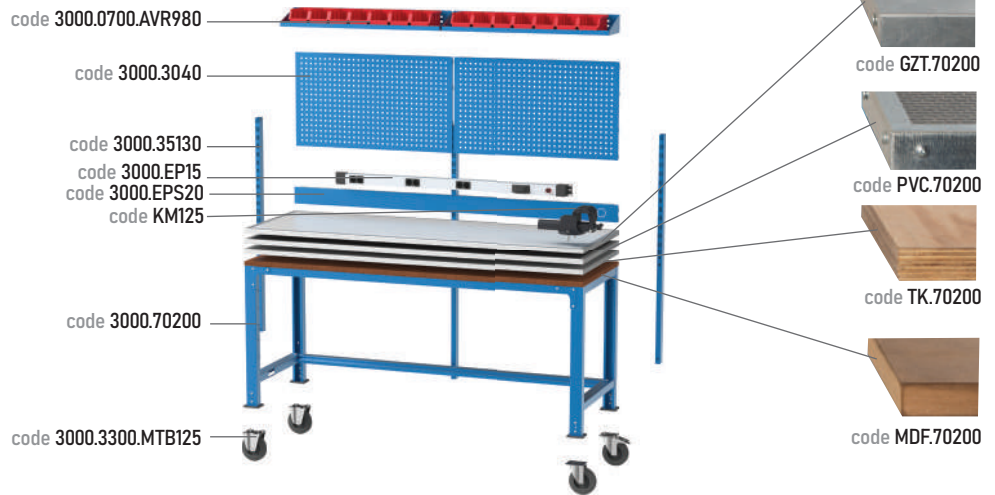



	code 3000.MDF.5712	code 3000.MDF.5717	code 3000.MDF.5722	code 3000.MDF.5728
	code 3000.PVC.5712	code 3000.PVC.5717	code 3000.PVC.5722	-----
	code 3000.TK.5712	code 3000.TK.5717	-----	-----
	code 3000.GZT.5712	code 3000.GZT.5717	code 3000.GZT.5722	-----

KOCEL



	code 3000.MDF.7214	code 3000.MDF.7221	code 3000.MDF.7228
	code 3000.PVC.7214	code 3000.PVC.7221	code 3000.PVC.7228
	code 3000.TK.7214	code 3000.TK.7221	-----
	code 3000.GZT.7214	code 3000.GZT.7221	-----

KOCEL

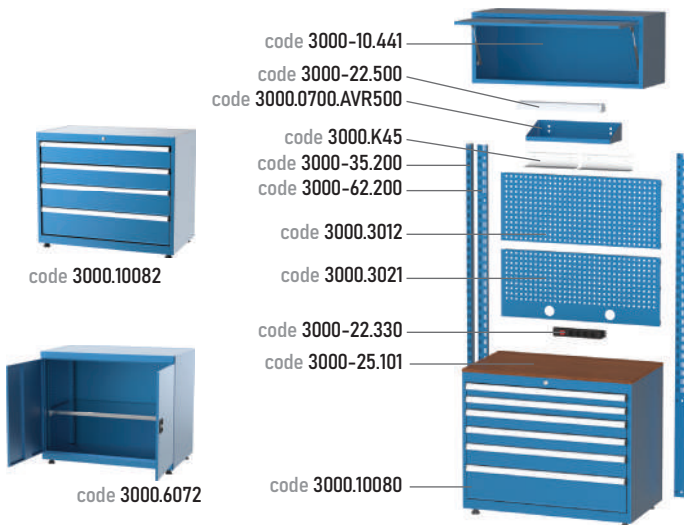

	code 3000.MDF.5720	code 3000.MDF.5730
	code 3000.PVC.5720	code 3000.PVC.5730
	code 3000.TK.5720	-----
	code 3000.GZT.5720	-----

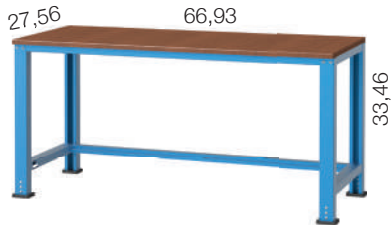

code 3324

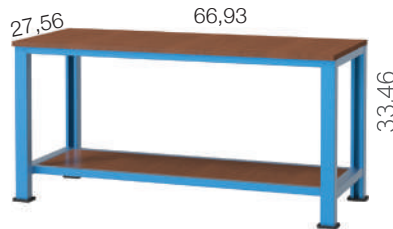

code 3325

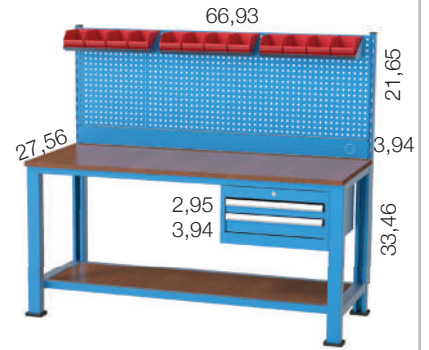

code 3700



code 3704



code 3745



code 3330

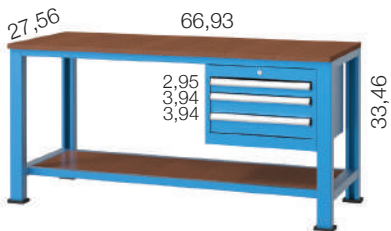

code 3710



code 3714

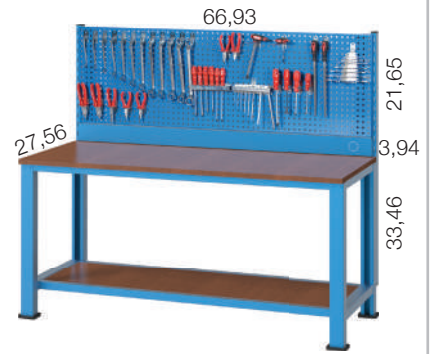

code 3750

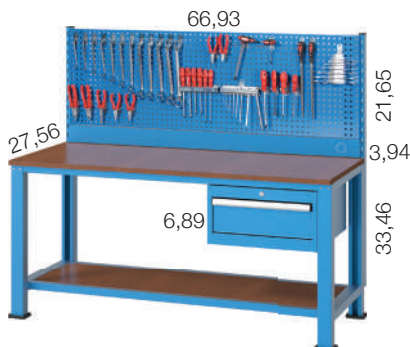

code 3755



code 3740

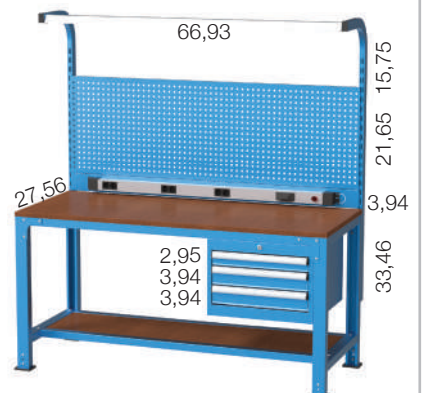

code 3770

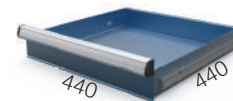
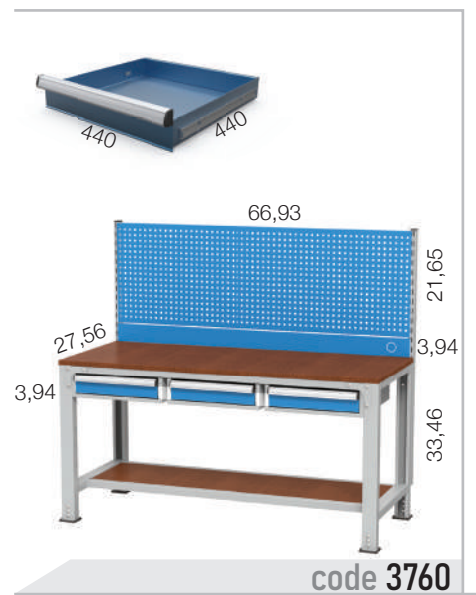
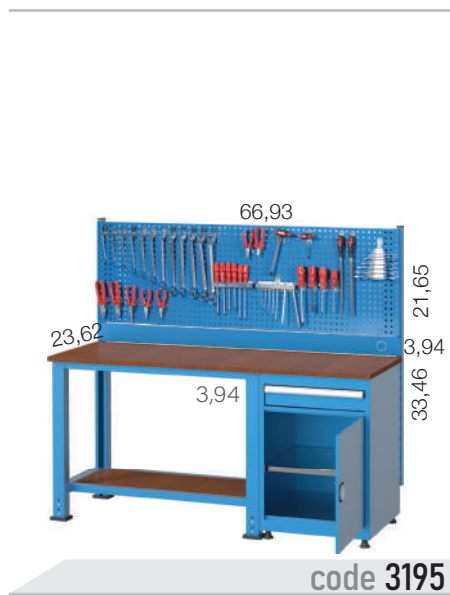
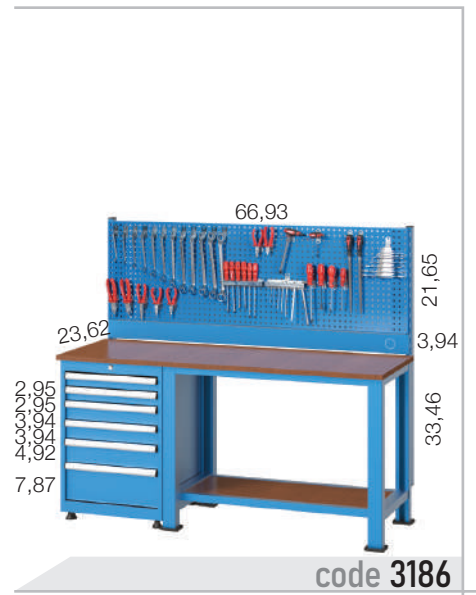
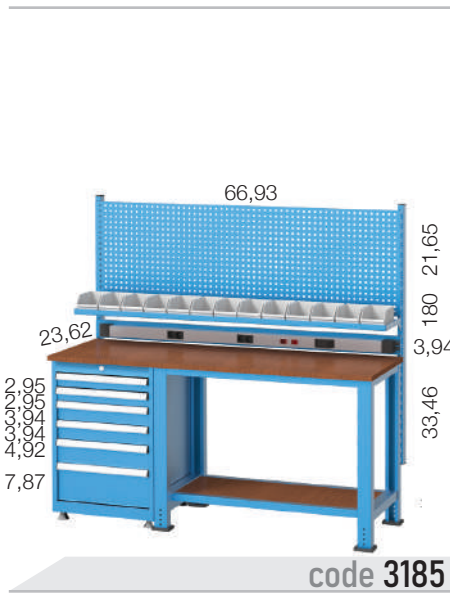
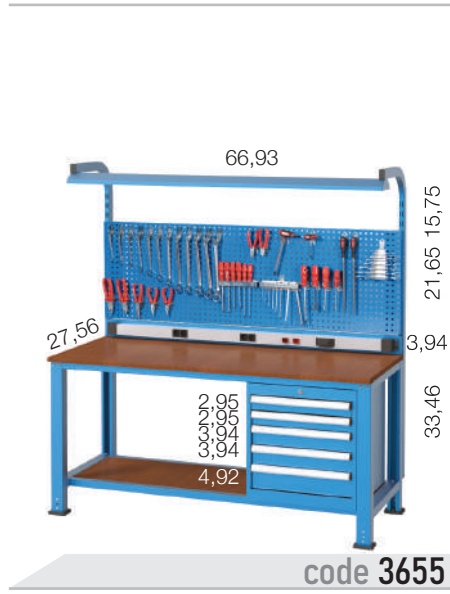

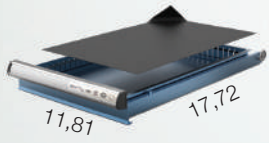

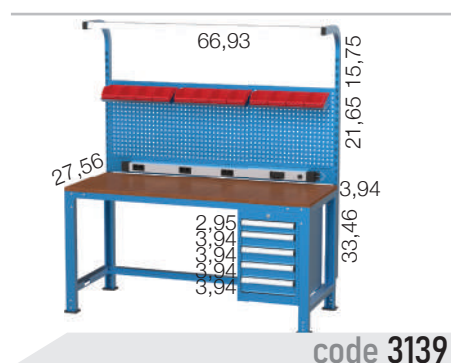
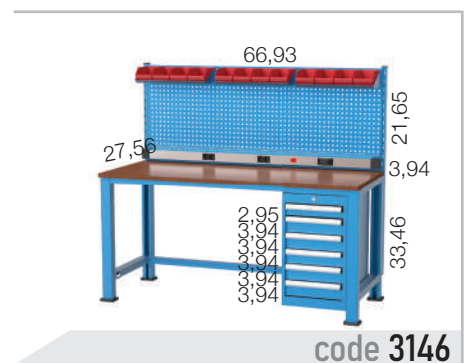
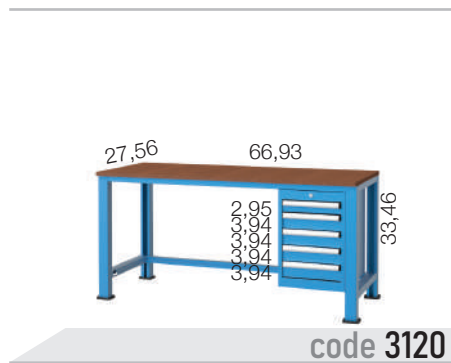
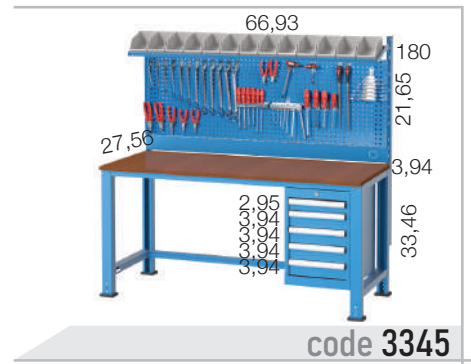
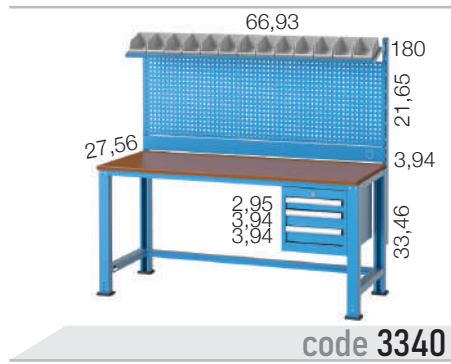
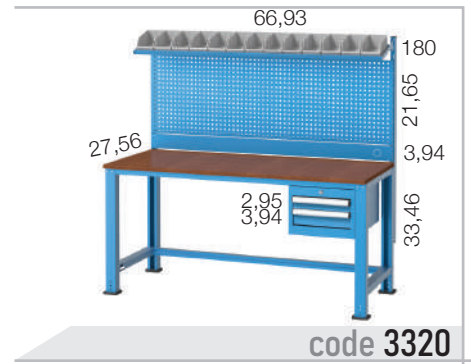
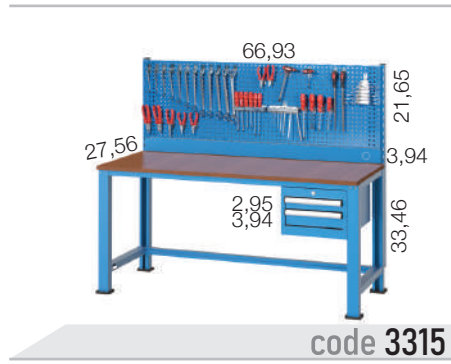



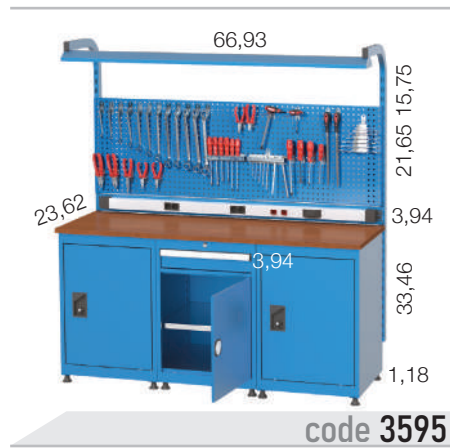
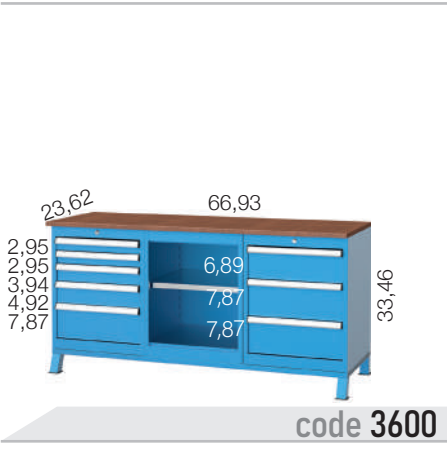



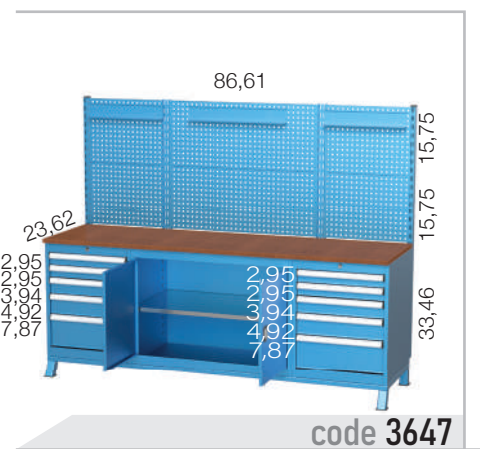
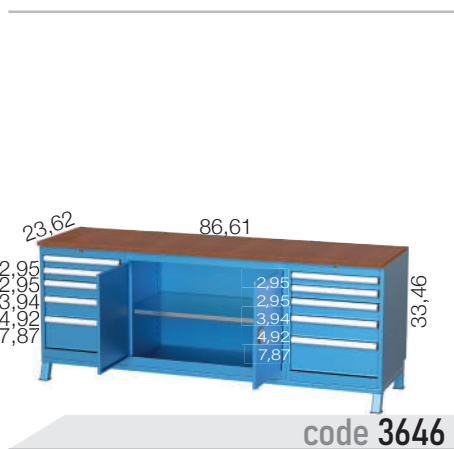
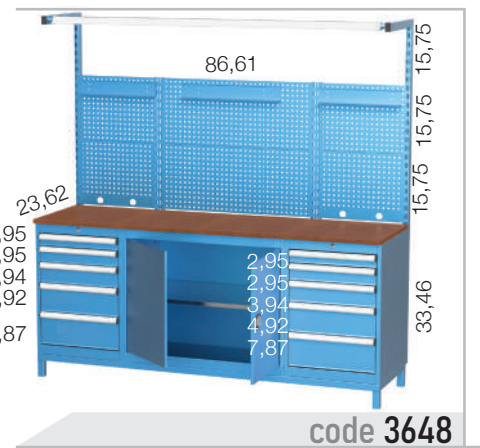
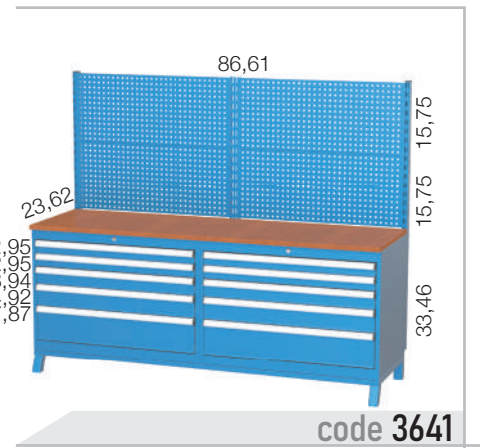
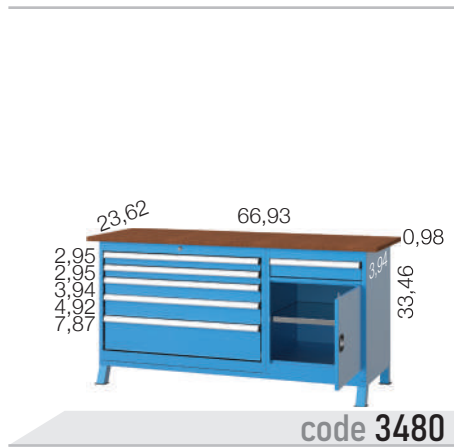
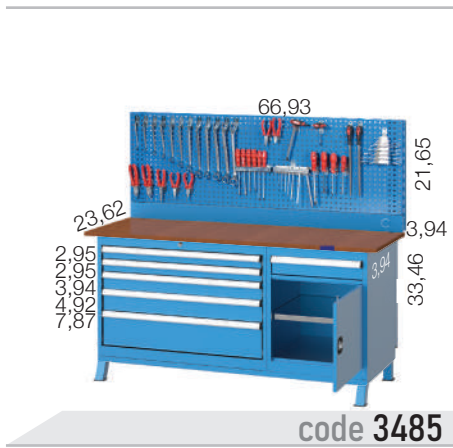
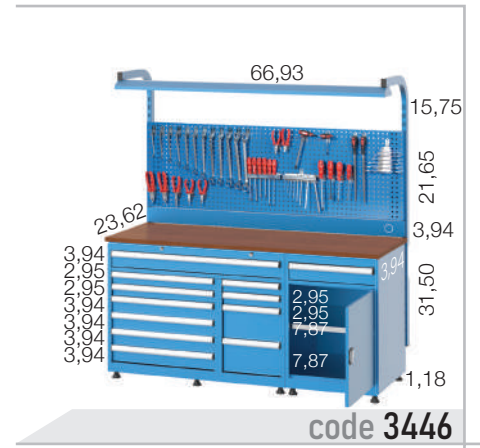
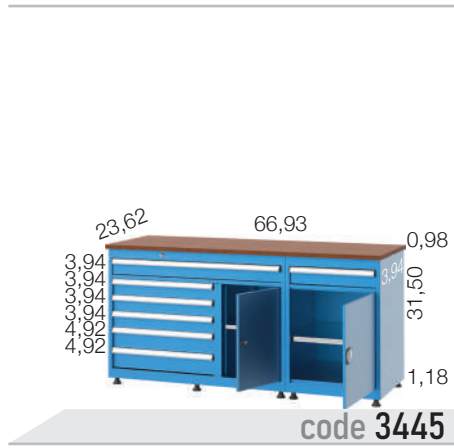
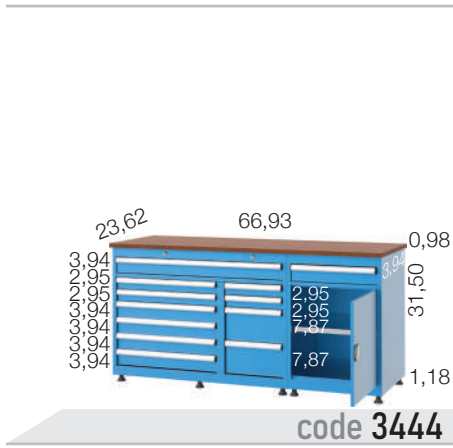

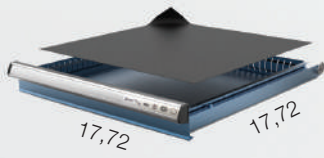

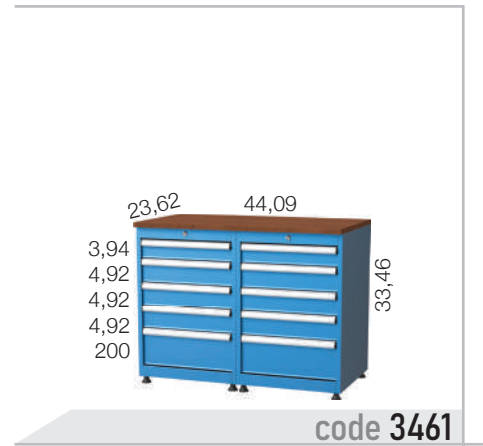
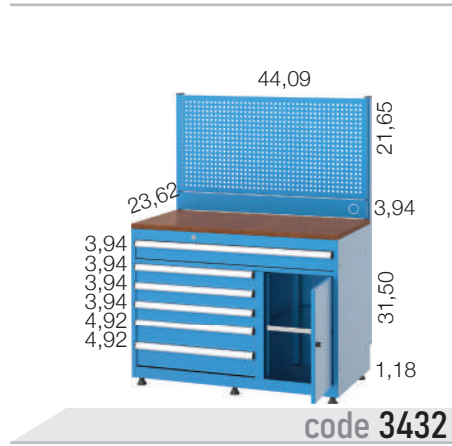
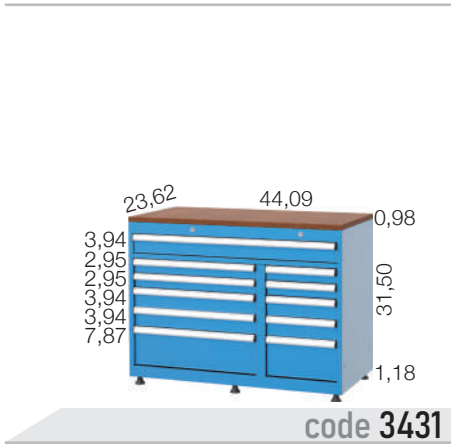



code 3360



code 3365

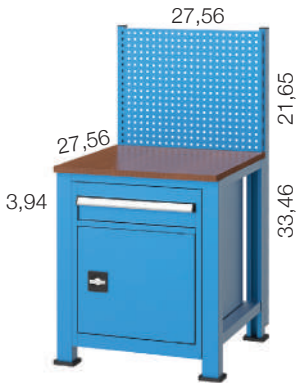

code 3390



code 3370



code 3375



code 3380

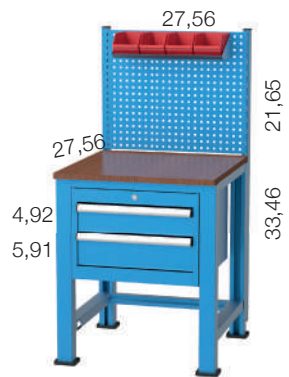

code 3385



code 3395

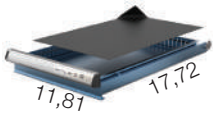

code 3936



code 3937



code 3941



code 3943



code 3942

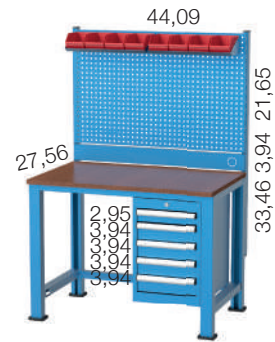

code 3944

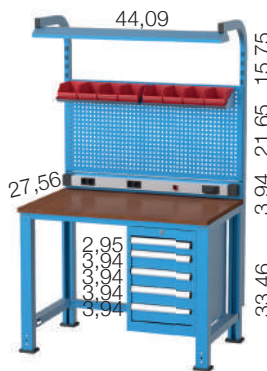

code 3945



code 3947



code 3949

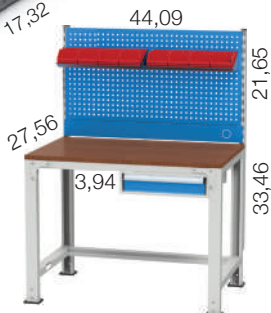
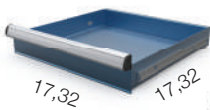

code 3948



code 3927

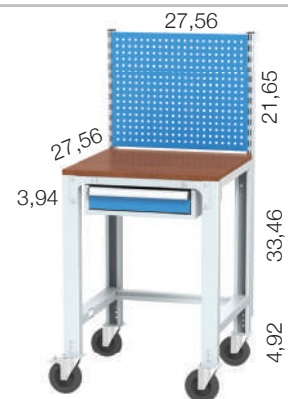

code 3381



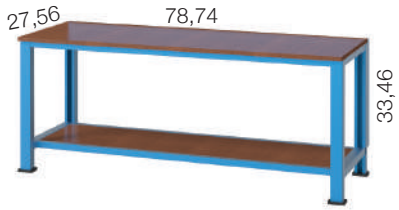

code 3211

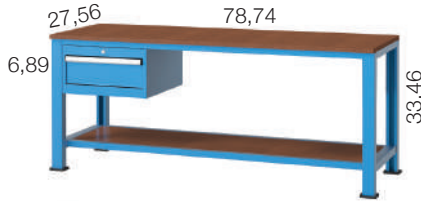

code 3214



code 3210

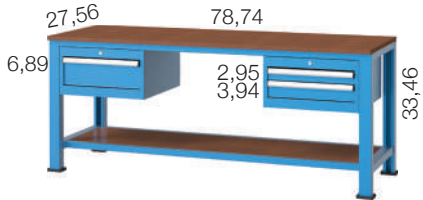

code 3215

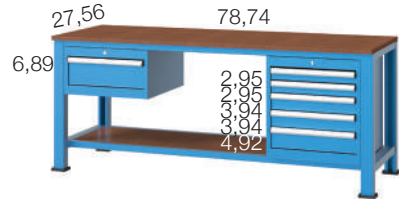

code 3220

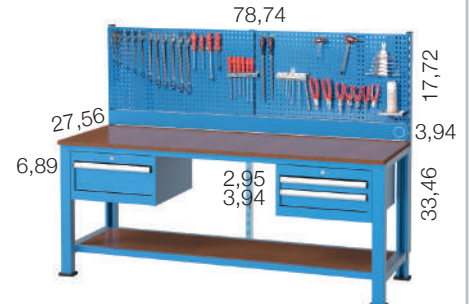

code 3205



code 3260

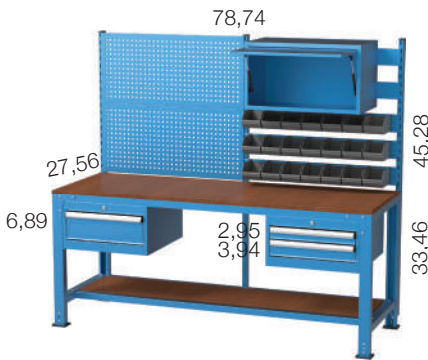

code 3265

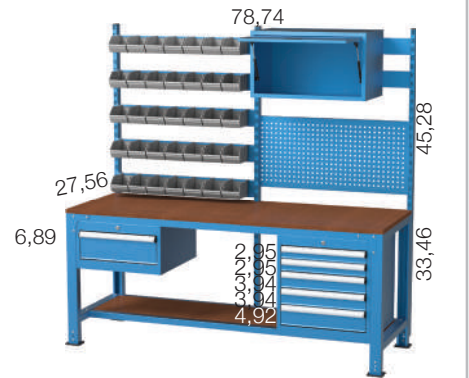

code 3270



code 3275

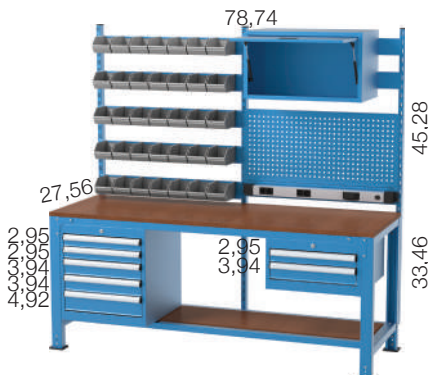

code 3280



code 3350





code 3781



code 3772



code 3783



code 3784



code 3785

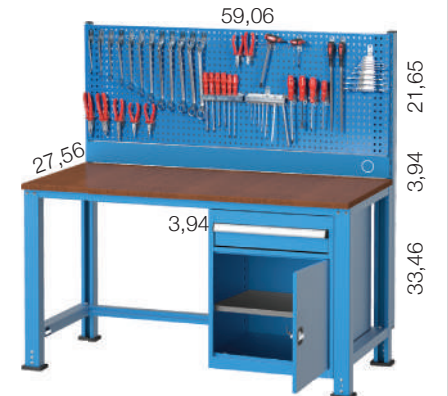

code 3786



code 3787

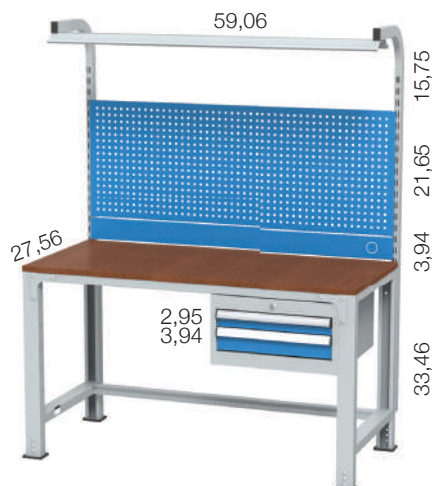

code 3788

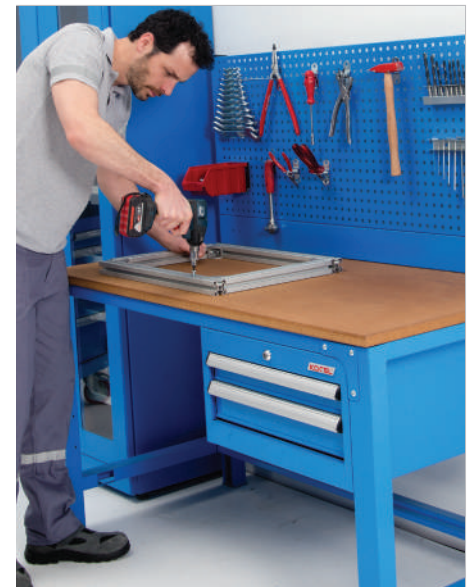



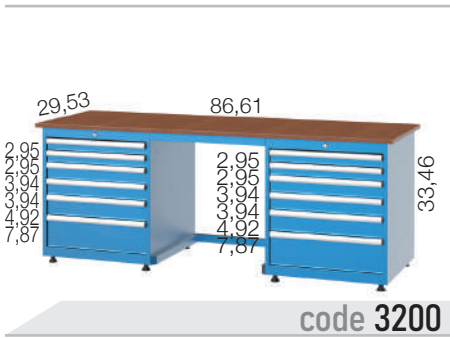
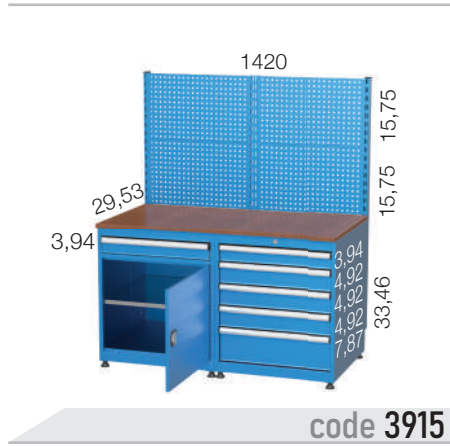



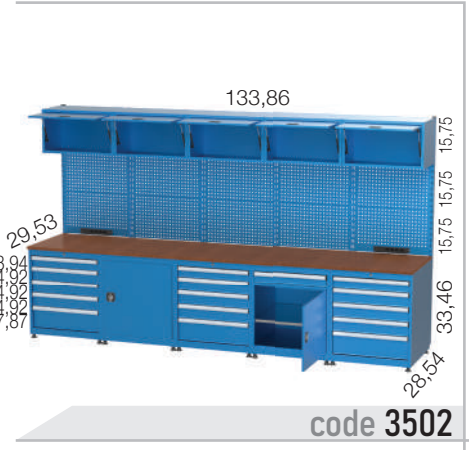
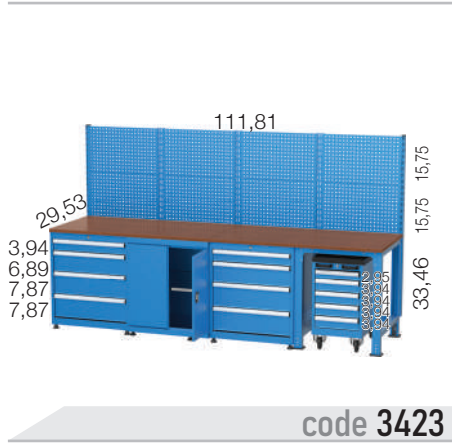
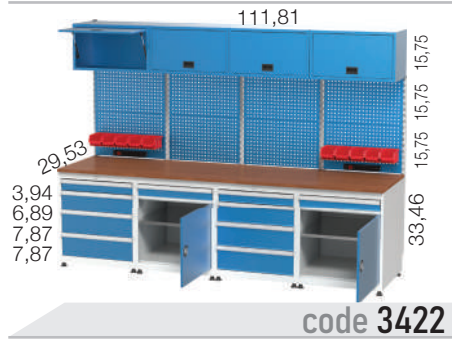
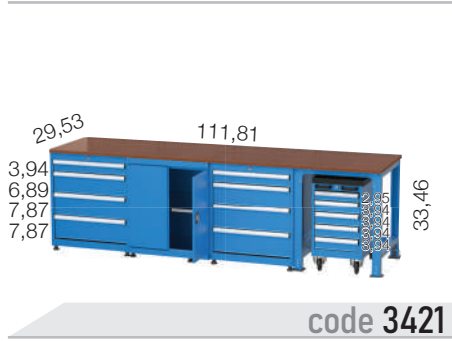





code 3661



code 3662



code 3663



code 3664

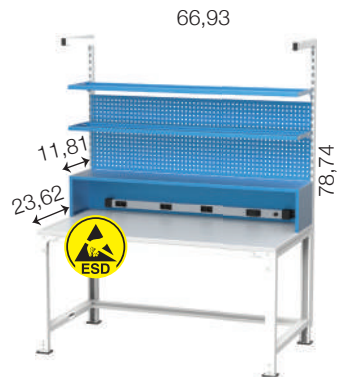

code 3651

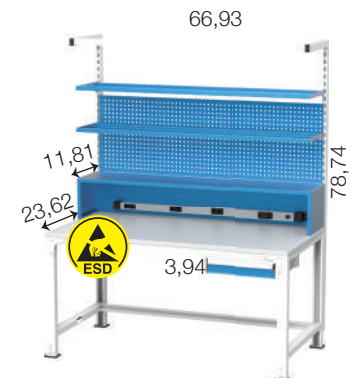

code 3652



code 3653

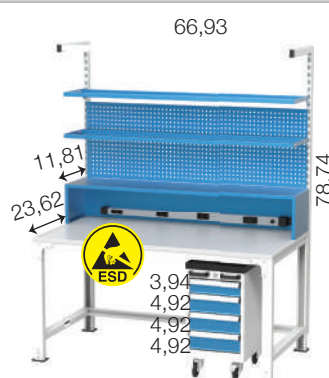

code 3654

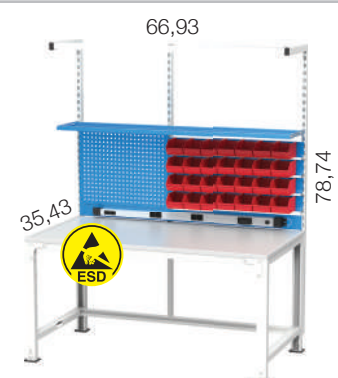

code 3656

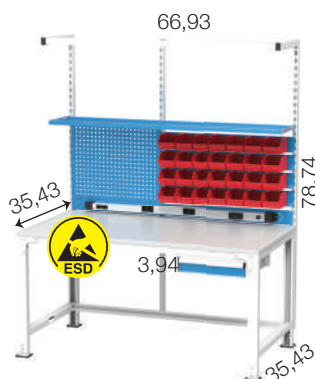

code 3657



code 3658

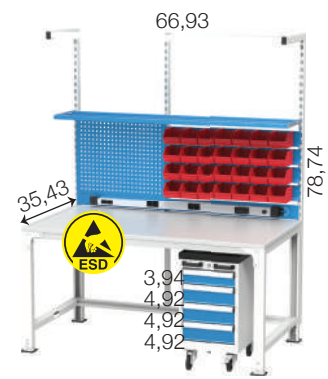

code 3659

27x27 E



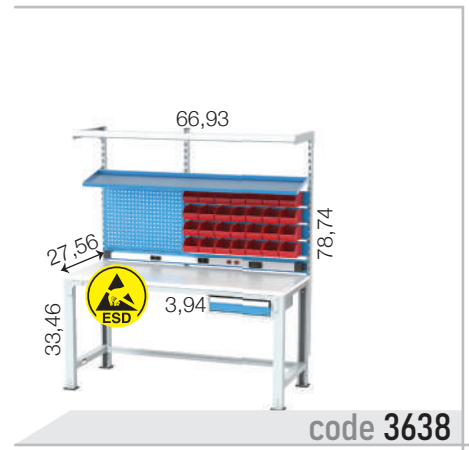
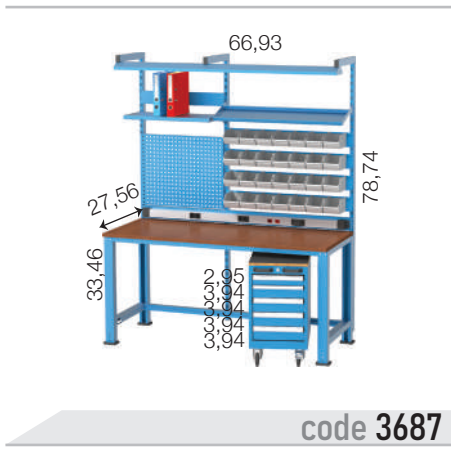
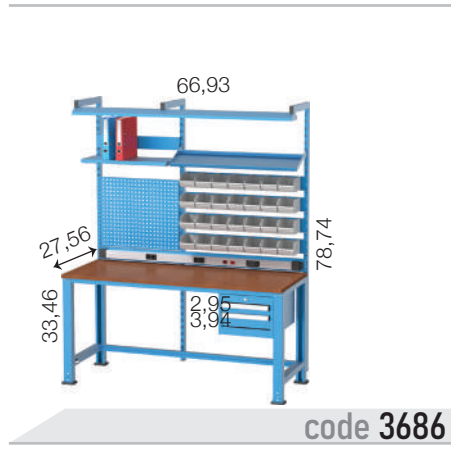





code 3406



code 3407



code 3409



code 3408



code 3411

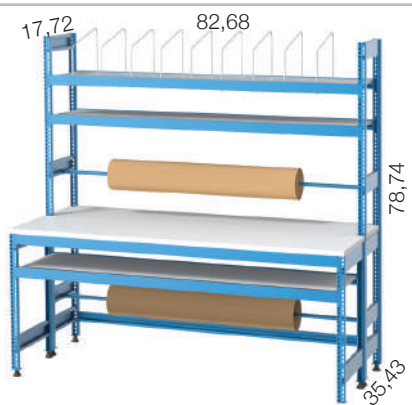

code 3412

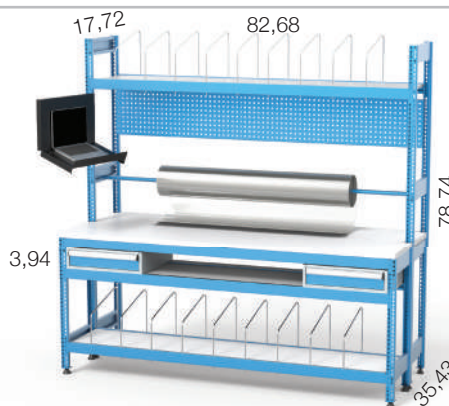

code 3413



code 3416

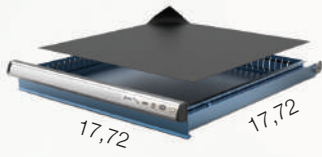

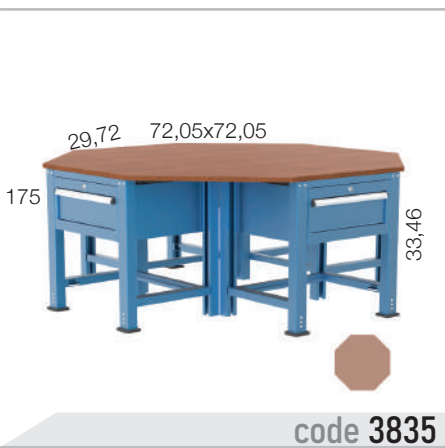
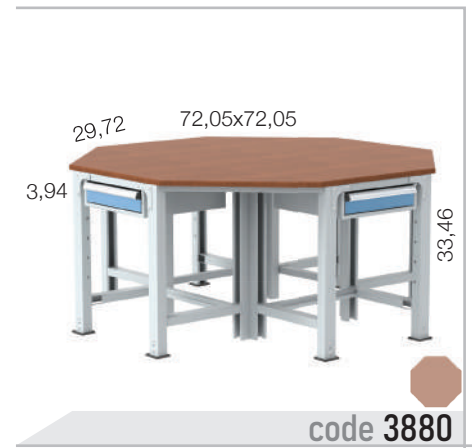
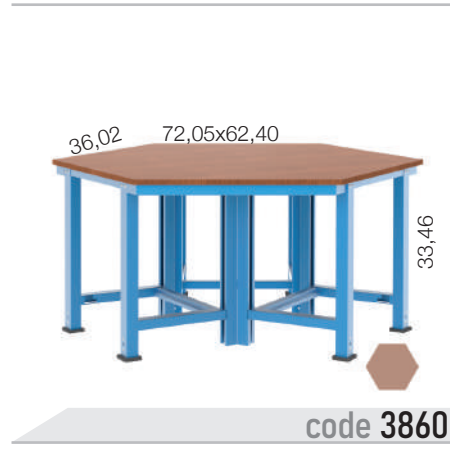

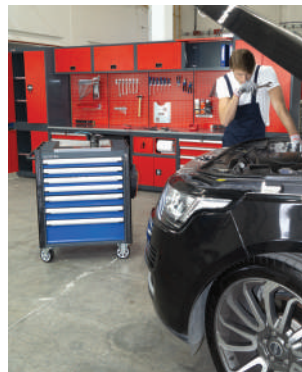



code 8955



code 8960



code 8965



code 8970



code 8975

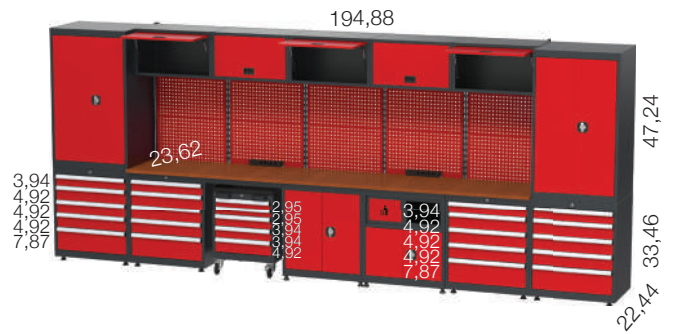

code 8980



code 8985



code 8990

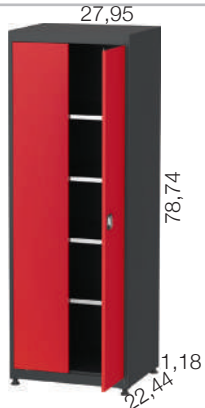

code 8900-75.2000



code 8900-75.1200



code 8900-75.080



code 8900-75.082



code 8900-75.085



code 8900-75.081



CORNER BENCH
code 8900-75.778



code 8900-75.447

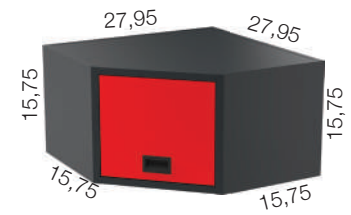

code 8900-75.477



code 8900-56.064



code 8900-56.065



code 8900-56.066

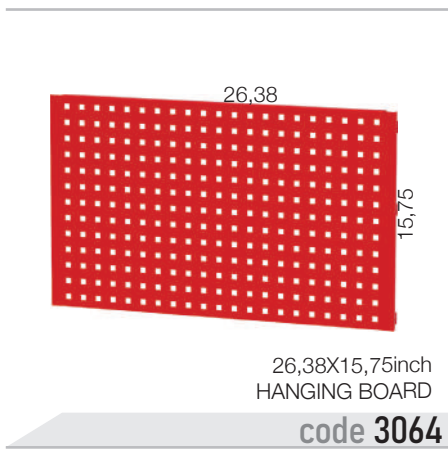
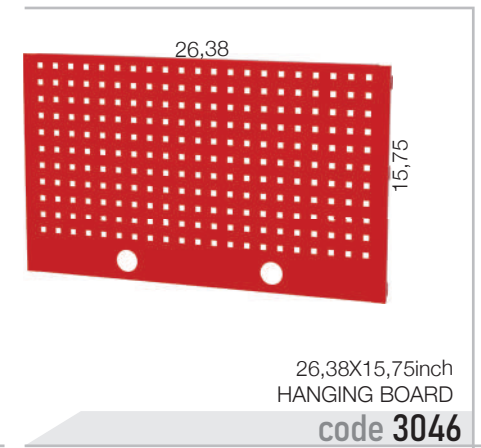
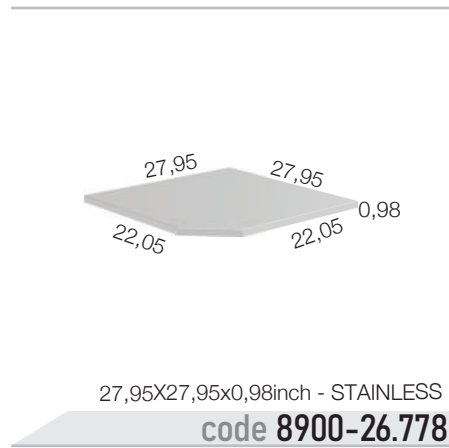
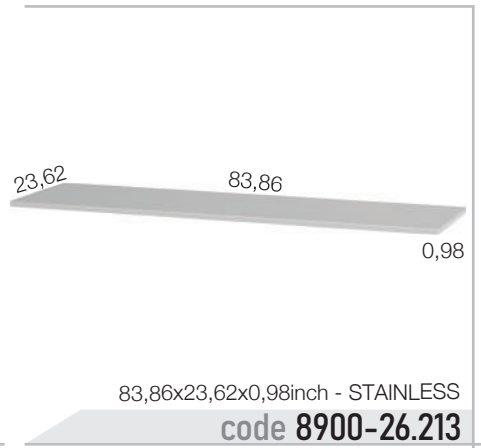
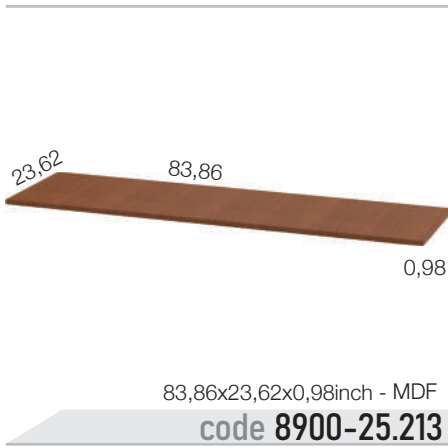
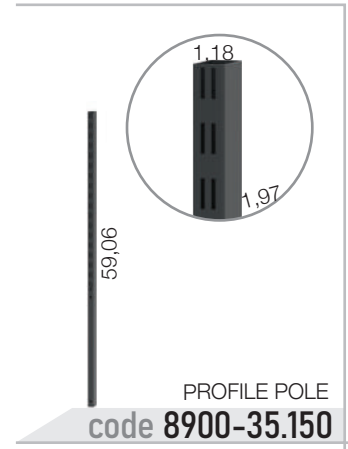
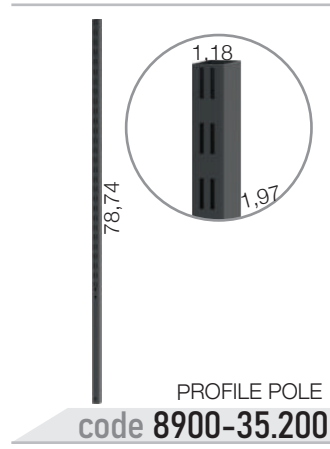
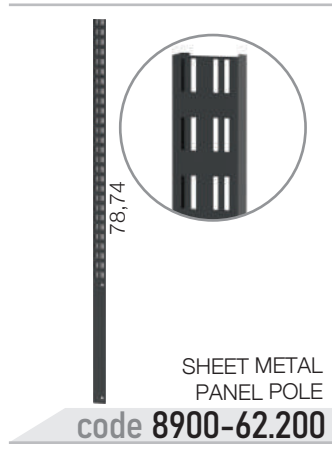
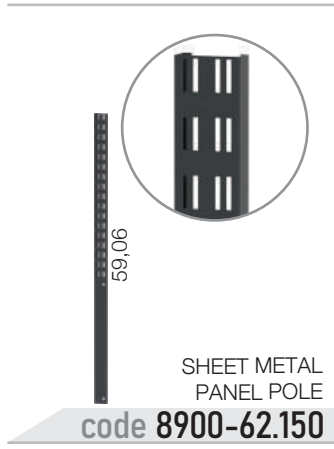

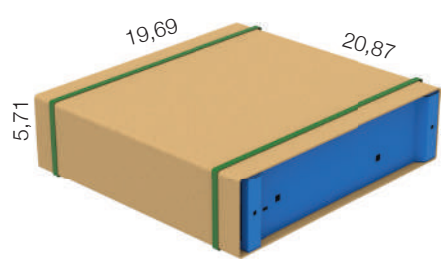
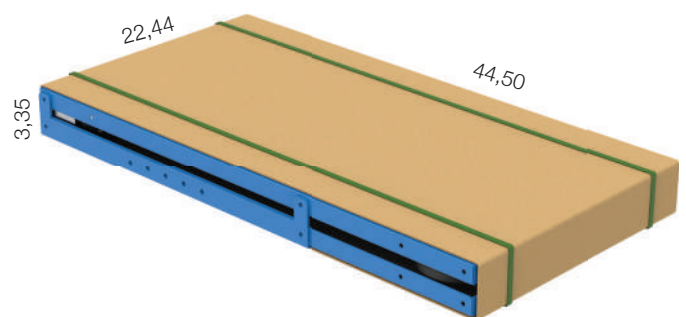
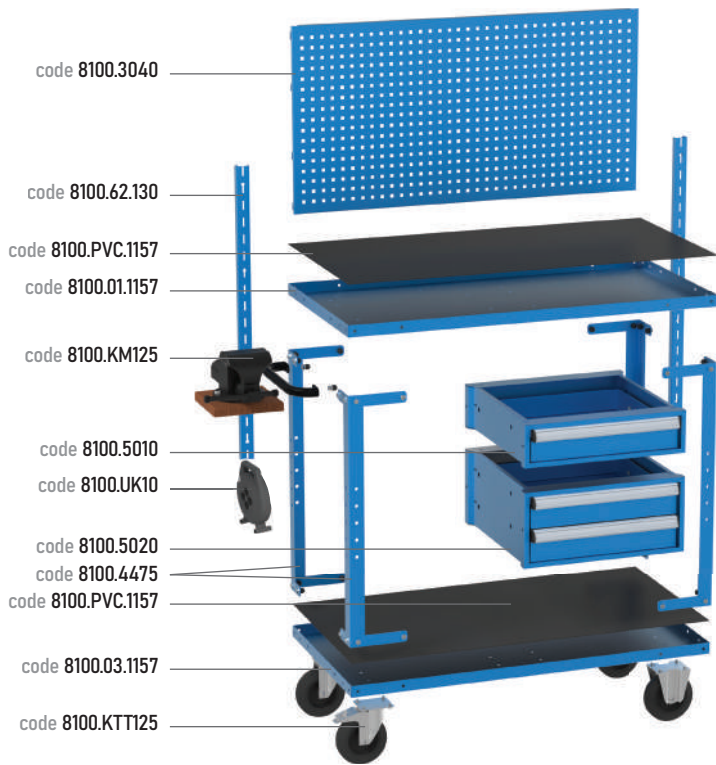



code 8011



code 8012



code 8013



code 8014



code 8009



code 8002



code 8001



code 8007



code 8005



code 8004

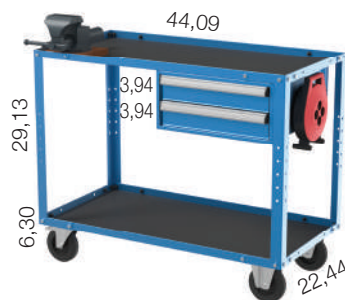

code 8006

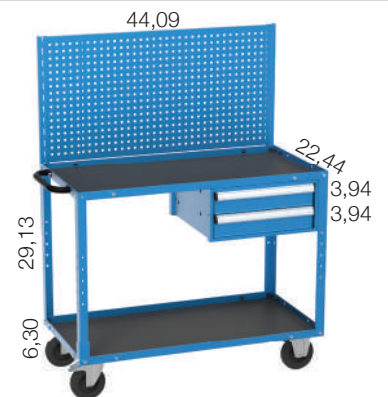

code 8003

27x27 E

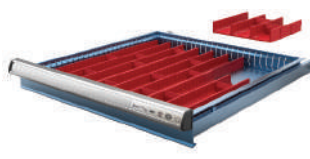
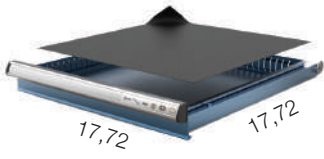

Pulling Handle



Wheeled



MDF Slab



Central Lock



Espagnolette Lock



Professional Labelling



Safety Latch

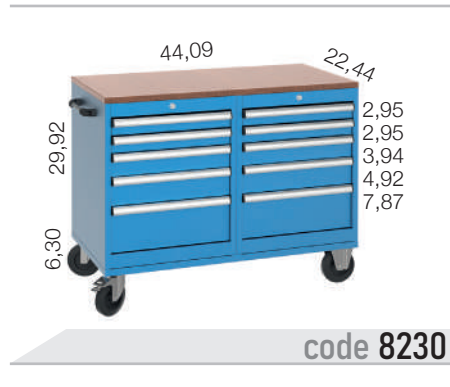
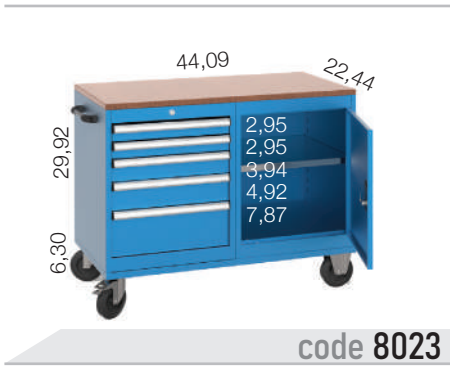
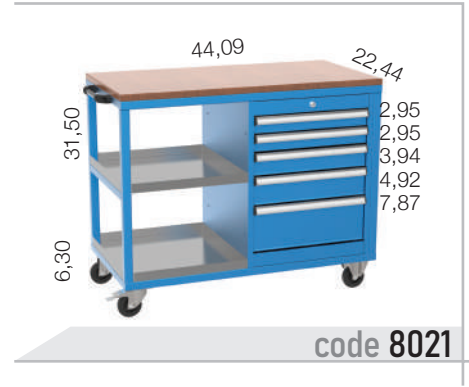
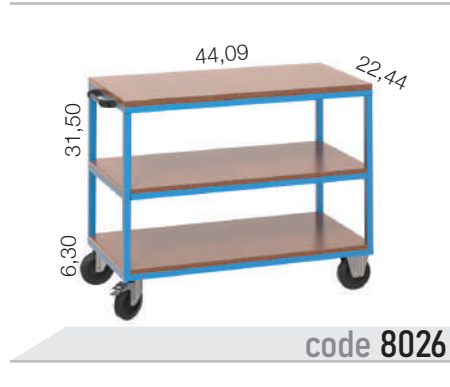
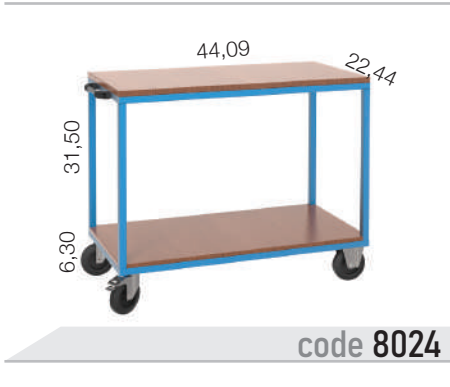

36X27 E



27X27 E



18X27 E

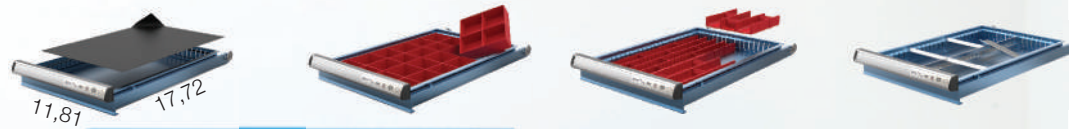

Pulling Handle



Professional Labelling



Safety Latch



Central Lock



Espagnolette Lock

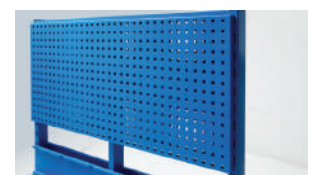

Pegboard



Wheeled



MDF Slab





code 8330



code 8310



code 8325



code 8315

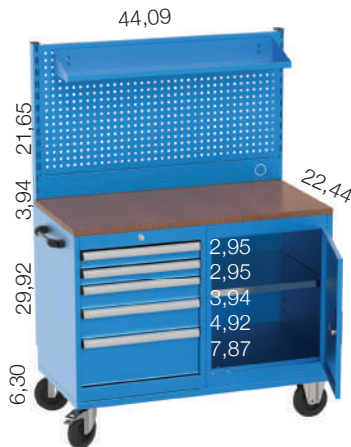

code 8225

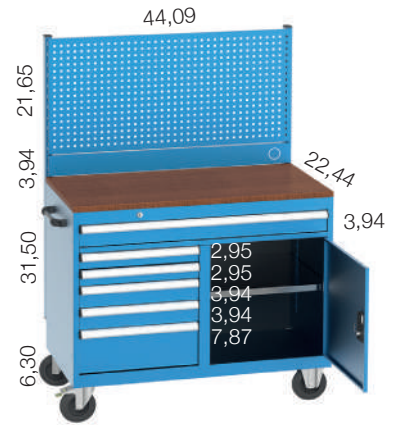

code 8340



code 8053



code 8030

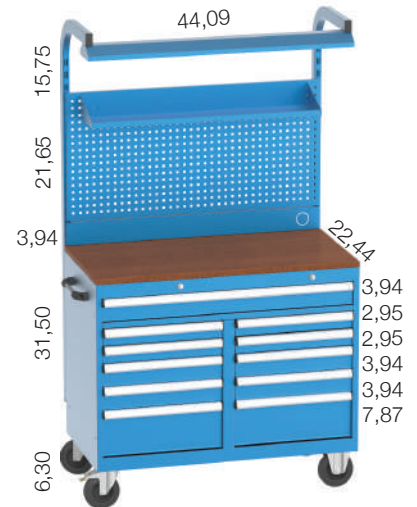

code 8345

36X27 E



27X27 E



18X27 E

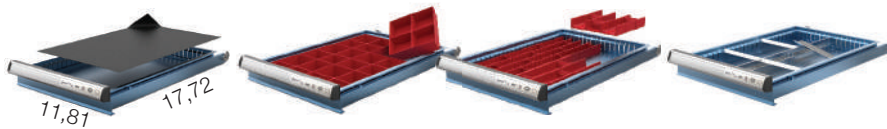

Pulling Handle



Professional Labelling



Safety Latch



Central Lock



Espagnolette Lock

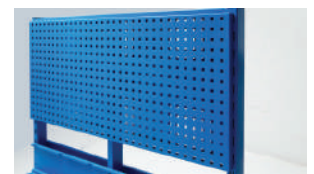

Pegboard



Wheeled



MDF Slab





code 8405

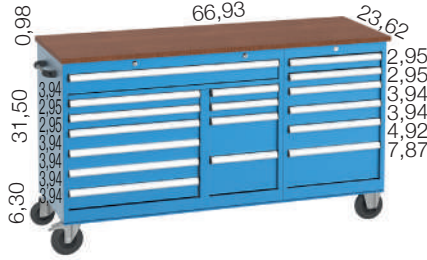

code 8435



code 8415

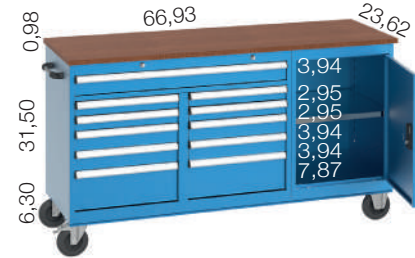

code 8420



code 8430



code 8440



code 8460

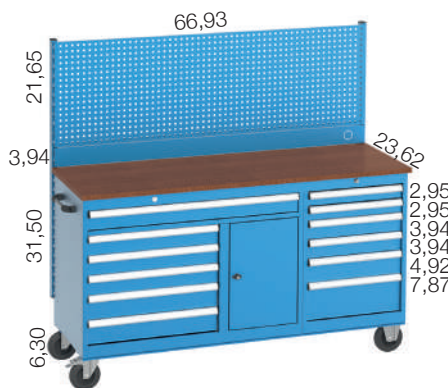

code 8410



code 8425



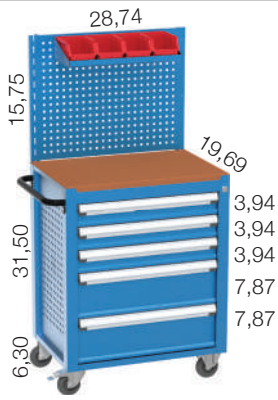

code 8597

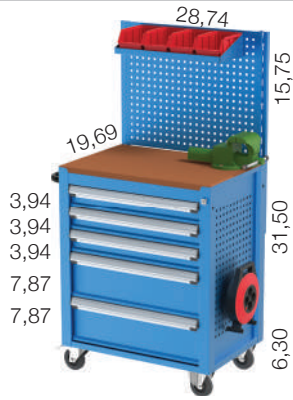

code 8595

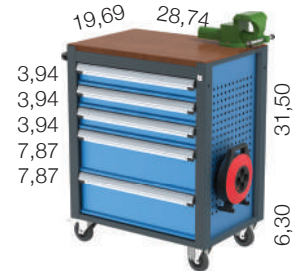

code 8585



code 4040



code 5070



code 8535

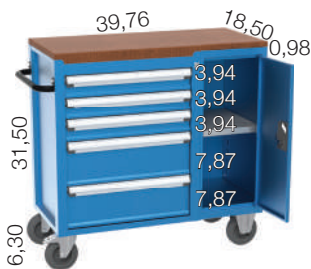

code 8537



code 8536



code 8538

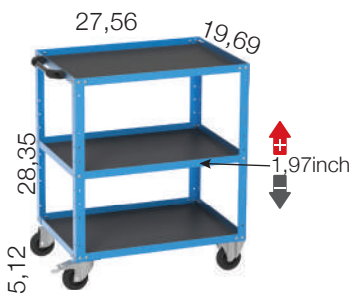

code 8540

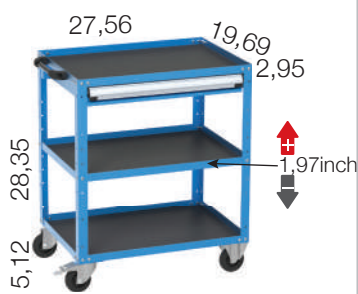

code 8545

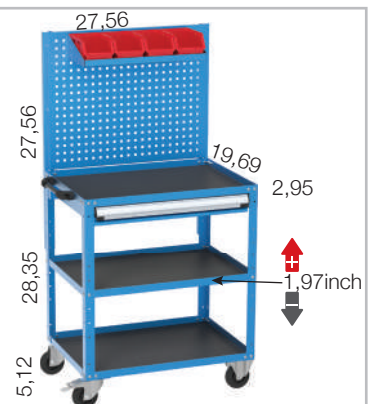

code 8547



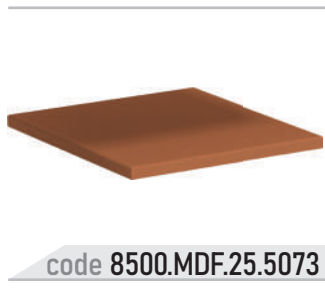
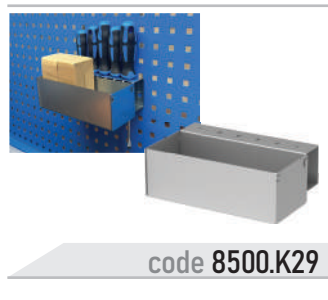
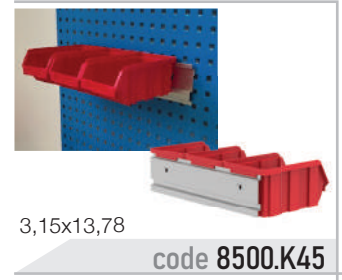
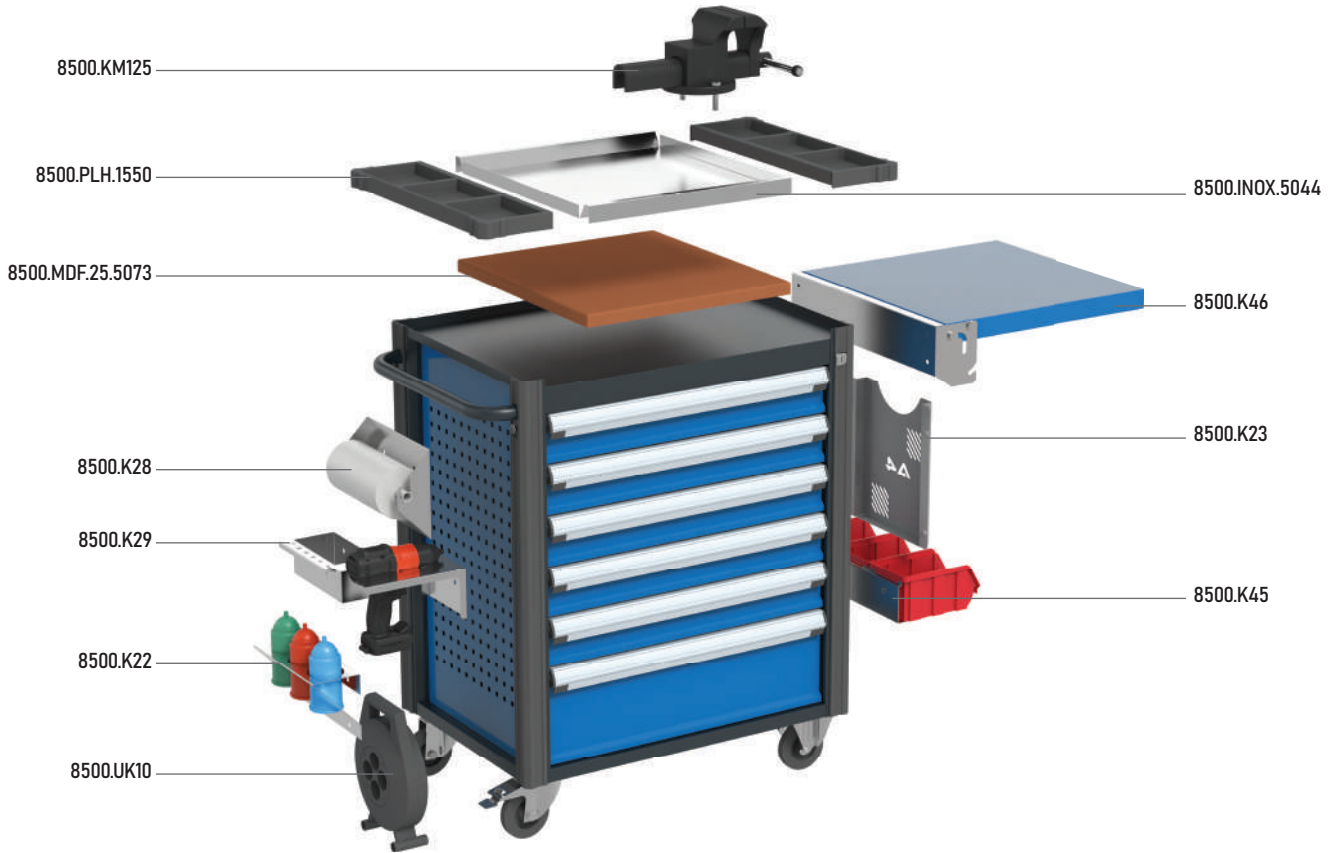





code 8513

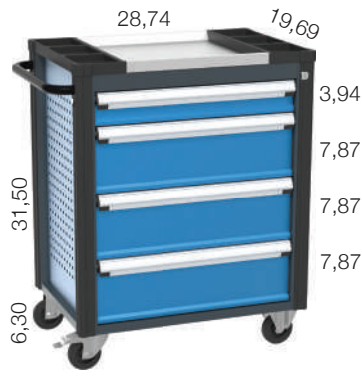

code 8514

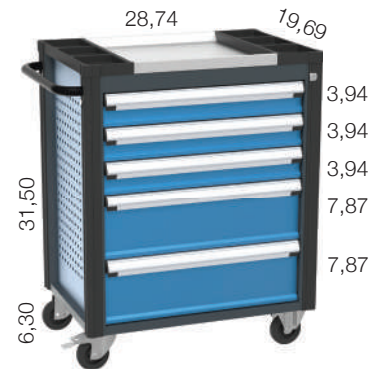

code 8515

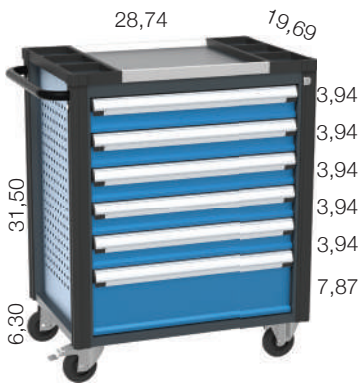

code 8516

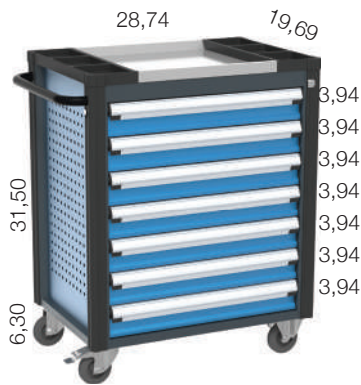

code 8517

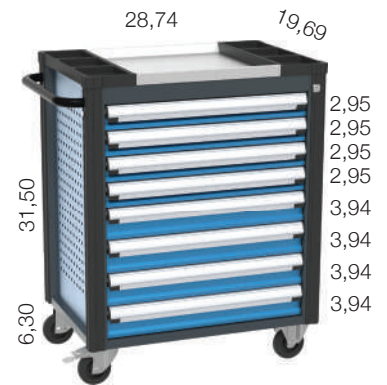

code 8518

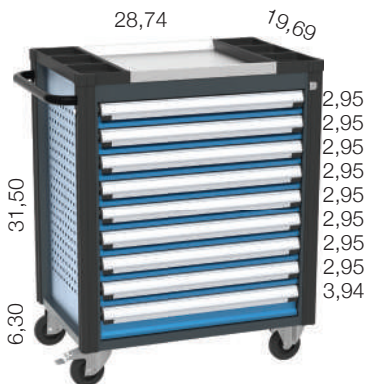

code 8519



code 8587







code 4070



code 4225



code 4230



code 4440



code 4445



20,47
15,75
0,79

code 3056

26,38
15,75
0,79

code 3064

38,19
15,75
0,79

code 3012

85,83
21,65
0,79

code 3035

65,35
21,65
0,79

code 3000

57,48
21,65
0,79

code 3045

38,58
17,72
0,79

code 3040

42,52
27,56
0,79

code 3010

42,52
21,65
0,79

code 3015

42,52
41,34
0,79

code 3005

26,77
21,65
0,79

code 3025

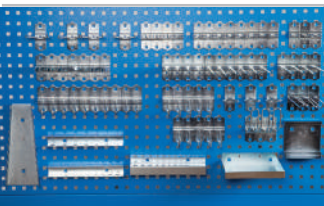

75 Pcs Hook Set

- K1 :15 Pcs
- K2 : 4 Pcs
- K3 : 7 Pcs
- K4 :10 Pcs
- K5 : 3 Pcs
- K6 : 3 Pcs
- K7 : 3 Pcs
- K8 :10 Pcs
- K9 : 1 Pcs
- K10 : 1 Pcs
- K11 : 1 Pcs
- K12 : 1 Pcs
- K13 : 1 Pcs
- K16 : 1 Pcs
- K15 : 4 Pcs

code 300-75

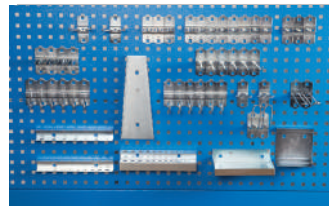

50 Pcs Hook Set

- K1 :14 Pcs
- K2 : 6 Pcs
- K3 : 4 Pcs
- K4 : 6 Pcs
- K5 : 2 Pcs
- K6 : 2 Pcs
- K7 : 2 Pcs
- K8 : 6 Pcs
- K9 : 1 Pcs
- K10 : 1 Pcs
- K11 : 1 Pcs
- K12 : 1 Pcs
- K13 : 1 Pcs
- K16 : 1 Pcs
- K15 : 2 Pcs

code 300-50

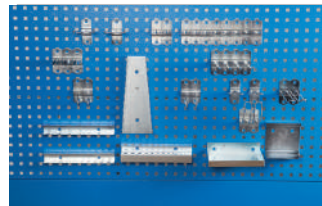

35 Pcs Hook Set

- K1 :10 Pcs
- K2 : 4 Pcs
- K3 : 3 Pcs
- K4 : 2 Pcs
- K5 : 2 Pcs
- K6 : 2 Pcs
- K7 : 2 Pcs
- K8 : 2 Pcs
- K9 : 1 Pcs
- K10 : 1 Pcs
- K11 : 1 Pcs
- K12 : 1 Pcs
- K13 : 1 Pcs
- K16 : 1 Pcs
- K15 : 2 Pcs

code 300-35

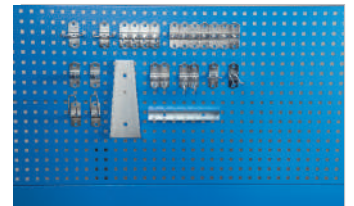

25 Pcs Hook Set

- K1 : 7 Pcs
- K2 : 4 Pcs
- K3 : 2 Pcs
- K4 : 2 Pcs
- K5 : 1 Pcs
- K6 : 1 Pcs
- K7 : 2 Pcs
- K8 : 2 Pcs
- K10 : 1 Pcs
- K11 : 1 Pcs
- K15 : 2 Pcs

code 300-25

L: 1,97inch
Ø: 0,16inch

code 31

L: 5,63inch
Ø: 0,20inch

code 32

Ø: 0,47-1,18inch

code 33

r: 0,87inch
Ø: 0,16inch

code 34

r: 1,57inch
Ø: 0,16inch

code 35

L: 5,51inch
Ø: 0,16inch

code 36

r: 3,15inch
Ø: 0,16inch

code 37

r: 1,57inch
Ø: 0,16inch

code 38

Ø: 0,08-0,55inch

code 39

Ø: 0,28-0,47inch

code 310

Ø: 0,24-0,31inch

code 311

A150
Tool Box

code 312

Ø: 0,12-0,47inch

code 313

11,81x5,91x1,18

code 331

r: 2,13inch
Ø: 0,16inch

code 315

7,87x4,33x2,76

code 333

Ø: 2,76inch

code 322

8,66x0,98x11,81

code 323

Folder

3,15x11,81x12,60

code 319

4,33x1,38x14,76

code 324

11,42x5,12x3,94

code 328

Adjustable touch screen console

code 330

Adjustable A100 tool console

code 335

3,15x13,78

code 345

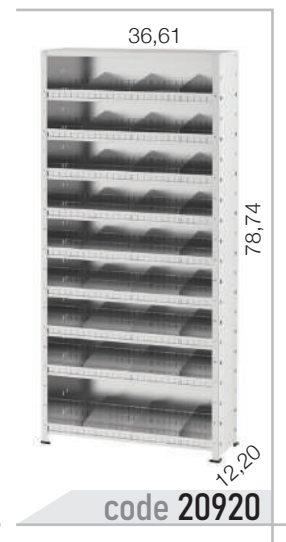
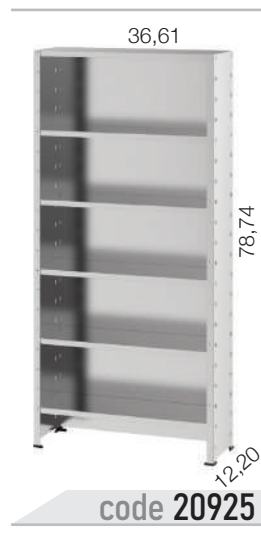
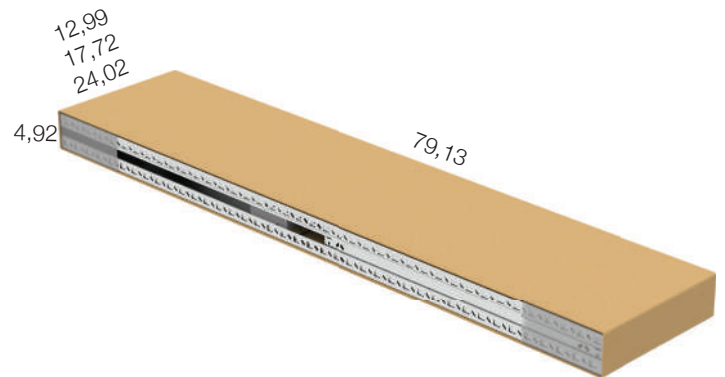

MINIRACK SHELF SYSTEMS



H	D	LAYERS	L 29,52 / LBS	L 39,37 / LBS	L 49,21 / LBS	L 59,05 / LBS	L 29,52 / LBS	L 39,37	L 49,21	L 59,05
78,74	19,69	5	39,37	661,38	440,92	330,69	20.550.075	20.550.100	20.550.125	20.550.150
78,74	23,62	5	39,37	661,38	440,92	330,69	20.560.075	20.560.100	20.560.125	20.560.150



H	D	LAYERS	L 29,52 / LBS	L 39,37 / LBS	L 49,21 / LBS	L 59,05 / LBS	L 29,52 / LBS	L 1000	L 1250	L 1500
78,74	19,69	5	39,37	661,38	440,92	330,69	20.551.075	20.551.100	20.551.125	20.551.150
78,74	23,62	5	39,37	661,38	440,92	330,69	20.561.075	20.561.100	20.561.125	20.561.150



H	D	LAYERS	L 29,52 / LBS	L 39,37 / LBS	L 49,21 / LBS	L 59,05 / LBS	L 29,52 / LBS	L 1000	L 1250	L 1500
98,43	19,69	5	39,37	661,38	440,92	330,69	25.550.075	25.550.100	25.550.125	25.550.150
98,43	23,62	5	350	661,38	440,92	330,69	25.560.075	25.560.100	25.560.125	25.560.150



H	D	LAYERS	L 29,52 / LBS	L 39,37 / LBS	L 49,21 / LBS	L 59,05 / LBS	L 29,52 / LBS	L 1000	L 1250	L 1500
98,43	19,69	5	39,37	661,38	440,92	330,69	25.551.075	25.551.100	25.551.125	25.551.150
98,43	23,62	5	39,37	661,38	440,92	330,69	25.561.075	25.561.100	25.561.125	25.561.150



code **20.44.0949.183**

code **20.44.1849.184**

code **20.44.1849.185**

code **20.44.0949.203**

code **20.44.1849.204**

code **20.44.1849.205**

PRACTICAL SHELF FOOT
code **20.44.090.4412**

PRACTICAL SHELF TRAVERS
code **20.44.90.612**

PRACTICAL SHELF TRAVERS
code **20.44.45.612**

GALVANIZED TABLE
code **20.44.945.020**

WHITE CHIPBOARD TABLE
code **20.44.945.018**

PRACTICAL SHELF INTERCONNECTION
code **20.44.020.4412**





MEDIUM TYPE SHELFING SYSTEMS

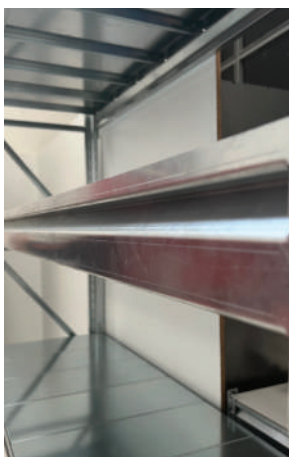

Traverse lengths	39,37	59,06	78,74
Order Code	CZ100	CZ150	CZ200
Carrying Capacity	34,43	23,62	17,72

H inch	B inch		
	23,62	31,50	39,37
78,74	20760	20780	207100
98,43	25760	25780	257100
118,11	30760	30780	307100

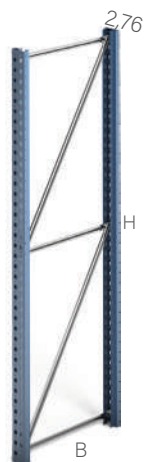



CHIPBOARD
TABLE

code TS1765



PLYWOOD
TABLE

code TK1770-1760-2260

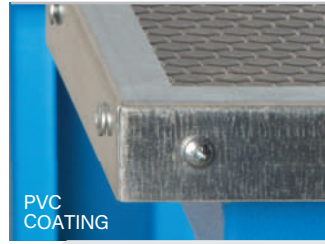

PVC
COATING

code PVC1770-1760-2260



GALVANIZED
COATING

code GZT1770-1760-2260



MDF
TABLE

code MDF1770-1760-2260



STAINLESS
COATING

code INOX1770-1760-1257



ESD
COATING

code ESD1770



MASSIVE
COATING

code MSF1770-1760



LIGHTING PANEL

code FTX-120 / FTX-170



QUAD
AIR JACK

code HJK4



ELECTRICAL PANEL

code EP15 / EP12

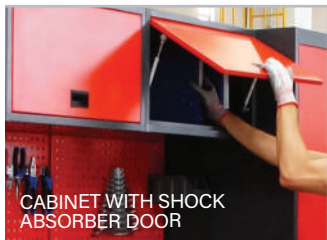

CABINET WITH SHOCK
ABSORBER DOOR

code 3000-71.447



EXTENSION
CABLE

code UK10



4,92inch
CLAMP

code KM125



4,92inch
CLAMP

code KM150



PLASTIC BIN HOLDER (66,93inch)

code AVK170



PLASTIC BIN HOLDER (38,58inch)

code AVK980



PLASTIC BIN HOLDER (38,58inch)

code AVR980



PLASTIC BIN HOLDER (19,69inch)

code AVR500



RUBBER WHEEL

code KTT100



RUBBER WHEEL

code KTT125



POLYURETHANE WHEEL

code PU100

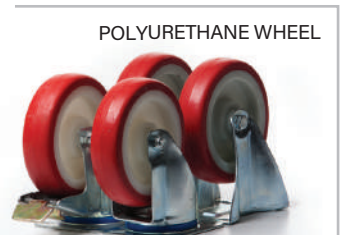

POLYURETHANE WHEEL

code PU125

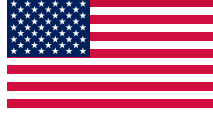

48

YEARS OF PASSION
FOR INNOVATION

KOCEL[®]A.S.

Export

e-mail : export@kocel.com.tr

Phone : +90 (533) 303 38 77

Head Office

Mahmutbey Mahallesi Köprü Caddesi No:10

Bağcılar / İSTANBUL / TÜRKİYE

e-mail : info@kocel.com.tr

Factory

GOSB 800. Sokak No:816-818

Gebze/KOCAELİ / TÜRKİYE

e-mail : info@kocel.com.tr

Germany Showroom

Mühlweg 12 73061 Ebersbach - GERMANY

Mobile: +49 173 690 28 28



E-mail

info@kocel.com.tr

www.kocel.com.tr

